



2022-2023 PRODUCT CATALOG

SPORT OPTICS & ACCESSORIES



www.barska.com



BARSKA. Sport Optics Products As Diverse As The Customers Who Use Them.

Since 1994, Barska®'s success and growth in the sport optics industry has been a direct result of our commitment "To Deliver Value, Quality and New Technology in Outdoor Products That Enhance the Consumer's Lifestyle". Year after year, we continually strive to provide our customers and valued retailers with the widest and most diverse selection of sport optics products available in the industry. By relentlessly working to achieve this goal, Barska® will continue to grow and be recognized as the brand of choice for the most innovative and extensive line of sport optics products available from riflescopes and binoculars to spotting scopes, shooting accessories, telescopes and other products that provide enjoyment to outdoor enthusiasts no matter what activities they pursue. In keeping with our goal of expanding and enhancing our product lines we have developed multiple new product for 2018, which are detailed in this catalog.

Riflescopes and Shooting Accessories

BARSKA riflescopes all have one thing in common: quality design and features that make them all an incomparable value. From the serious tactical and long-range shooter to the varmint hunter, big game hunter and recreational target shooter, there's a BARSKA rifle scope that's a perfect fit for you and your firearms.

Binoculars

The Level HD series of binoculars combine fully multi-coated lenses with high-quality BAK-4 prisms to deliver an impressively sharp and detailed image. The Level ED series of binoculars

are equipped with Extra Low Dispersion (ED) glass, these binoculars maximize image quality to provide an extraordinarily sharp and detailed image. The Crush Series of binoculars deliver high quality optics in a bright and colorful package. From compact to "jumbo" there is a Barska® binocular for every pursuit and they all share this in common – Barska®'s reputation for value, quality and new technology.

Spotting Scopes

A spotting scope is an indispensable tool for numerous endeavors: target shooting, bird watching, viewing nature, and even professional surveillance operations. The Level ED spotting scope is in a class of its own, combining extra low dispersion (ED) glass and a triplet apochromatic lens, resulting in crystal-clear images with enhanced color, contrast, and light transmission. Our Naturescape™ spotters are in a class of their own, combining high quality fully multi-coated optics and wide zoom range in a sleek "go-anywhere" compact body. The Level™ spotting scope series features a unique rubber armor that not only protects the body of the scope but also helps you to have a firm grip on the scope in bad weather. From compact and portable to large powerful and elegant to astronomy there's a Barska® spotting scope perfect for every outdoor adventure.

Loaded Gear™

Loaded Gear™ an innovative brand of products for today's active lifestyle. Loaded Gear™ is an extensive line of protective gear cases,

backpacks, gun cases, tactical protective gear and accessories in a variety of colors to choose from.

Winbest®

It's never been easier to judge "trash from treasure" with the Winbest® metal detectors. Most models are easy to use and operate, you'll be hunting for coins, relics, and other unseen treasures in no time!

Microscopes

Our digital microscopes are state-of-the-art integration of high quality microscope and a digital camera. Digital microscopes are great for educational purposes because several people can view the specimen at once on the microscope screen or PC screen. The digital microscope and imager that allows the user to stream high magnification images direct to a smart phone / mobile wifi enabled device.

We hope that this 2022 Product Catalog provides you with all of the product information and insight you need to select the Barska® rifle scope, binocular, spotting scope, telescope product or accessory that best meet your needs. We are committed to assisting you with the technical and customer support to ensure your continued enjoyment of the Barska® product that you select for years to come.



INDEX

Riflescopes		Loaded Gear	51	Spotting Scopes	
Level	6	Binoculars		Level ED	93
Level HD	7	Air View	65	Level	94
SWAT-AR	8	Level HD	66	Naturescape ED	95
Blackhawk	9	Level ED	67	Naturescape	96
AR6	10	Level	68	Benchmark DFS	97
SWAT	11	Crossover	69	Blackhawk ED	98
Benchmark	12	Crush	70	Blackhawk	98
Sniper	13	Cosmos	71	Spotter Pro	100
Tactical	14	X-Treme View	71	Tactical	101
Point Black	15	Blackhawk	72	Gladiator	101
Huntmaster Pro	16	Deep Sea	74	Colorado	102
Huntmaster	16	Floatmaster	75	Telescopes	
Hot Magnum	17	Battalion	76	Starwatcher	104
Euro-30 Pro	18	Escape	78	Classic Connoisseur Collection	
Euro-30	18	Focus Free	79	Anchormaster Scopes	106
Varmint	19	Trend	79	Anchormaster Opera Glasses	108
Contour	20	Gladiator	80	Winbest	110
Air Gun	22	X-Trail	82	Microscopes	117
Plinker-22	22	Lucid View	83		
Rimfire	22	Blueline Colorado	84		
AR-X Pro	23	NVX Night Vision	86		
AR-X	24	Encounter	87		
Electro Sights	25	Tripods	88		
Red Dot	28				
Lasers	29				
Flashlights	32				
Shooting Accessories	35				



For Additional Products
Check Out Our
Security Solutions
Catalog

RIFLESCOPES

BARSKA® PRECISION SCOPES & ACCESSORIES



BARSKA Riflescopes

The BARSKA Level HD series precision-engineered scopes make targeting easier with the help of an illuminated red and green reticle. A rheostat allows the user to quickly adjust the color and brightness of the reticle to better match the current environmental lighting situation. The compact size and low profile of our Contour series pair perfectly when mounted to a flat-top AR rifle and features external target turrets that can be locked secure to prevent movement of the scopes windage and elevation. The sniper scope series is designed for high-resolution spotting of distant targets where precision is an absolute necessity. The built-in sniper edged sun-shade is set back in the housing to allow the sun shade to cast a shadow

and reduce glare for use in bright sun. That gives the rifle scope a great look on any long range rifle or AR combat rifle. Check out our selection of FLX flashlights, GLX lasers and shooting accessories found in this catalog.

BARSKA riflescopes all have one thing in common: quality design and features that make them all an incomparable value. From the serious tactical and long-range shooter to the varmint hunter, big game hunter and recreational target shooter, there's a BARSKA rifle scope that's a perfect fit for you and your firearms.

RIFLESCOPE TERMINOLOGY

A riflescope is used to view distant targets and surrounding objects to make them appear closer, and also indicates a bullet's point of impact. A riflescope can provide safer and more accurate shooting.

MAGNIFICATION (POWER)

Magnification is the number of times the object being viewed is enlarged. Riflescopes are often identified by two numbers, for example: 6x42. The first number indicates the magnification or the power of the riflescope, expressed by the letter "x", for times. This means that the object being viewed appears to be 6 times closer than would be seen with the naked eye.



VARIABLE POWER/ZOOM

Zoom is the ability of the riflescope to change magnification continuously throughout its design range, providing a low power to high power range. For example, a 6-24x50mm riflescope has the ability to magnify an object from 6 to 24 times.

Low Power: Eg. 1.5-6x42, 2-7x32.

These riflescopes are ideal at close range and for shooting moving targets.

Medium Power: Eg. 3-9x50, 2.5-10x50.

These riflescopes are ideal for big-game hunting at medium range.

High Power: Eg. 6-24x50

These riflescopes are best for target shooting, small-game and varmint hunting.

OBJECTIVE LENS DIAMETER

The second number in the reference (i.e. 6x42) indicates the diameter of the objective lens or the front lens. The larger the objective lens, the better the light transmission, thus the brighter the image.

OPTICAL COATINGS

Various coating processes on the lenses and prisms will determine the brightness and the light gathering of a riflescope thus providing higher contrast and brighter images. The different types of coatings are:

Coated = A single layer on at least one lens surface.

Fully Coated = A single layer on all air-to-glass lens surfaces.

Multi-Coated = Multiple layers on at least one lens surface.

Fully Multi-Coated = Multiple layers on all air-to-glass surfaces.

FIELD OF VIEW (F.O.V)

The side-to-side linear measurement of the circular field seen through a riflescope. It is defined by the width in feet of the area visible at 100 yards, or in meters at 100m. The higher the magnification, the narrower the field of view.

RESOLUTION

The measurement of the riflescope's ability to distinguish fine detail and sharpness.

EXIT PUPIL

This refers to the size of the small disc of light that exits a riflescope. To determine the size, divide the objective lens diameter by the power. For example a 6x42 riflescope will have an exit pupil of 7mm. (42/6=7).

EYE RELIEF

This is the distance a scope can be held away from the human eye and can still observe the entire field of view. Long Eye Relief (LER) reduces eyestrain and provides an extra margin of comfort and safety.

TUBE DIAMETER

This refers to the diameter of the body of a riflescope; that portion between the belled ends.

WATERPROOF/FOGPROOF

Riflescopes can be O-ring sealed for waterproof protection, and fogproof which means that they are nitrogen-purged to prevent fogging inside the optical surfaces. These models are able to keep completely dry inside after immersion in water, thus suitable for a wide range of outdoor activities.

PARALLAX

A condition that exists when the image being viewed through a riflescope is not focused precisely on the reticle. Parallax can be detected by an out-of-focus image or moving image in relation to the reticle as you move your eye left to right, up and down while looking in the scope. Scopes with an adjustable objective or turret provides the advantage of parallax correction.

PRECISION ADJUSTMENTS

The windage and elevation adjustments affect accuracy and are used to zero-in on the scope. Windage is the horizontal (left-to-right) adjustment, usually the side turret of the scope. Elevation is the vertical (up-and-down) adjustment, usually the top turret of the scope. Adjustments are usually measured in click value. (1/4 MOA = 1/4" at 100 yards) for finer precision.

RETICLES

A reticle is the crosshair or pattern placed within the scope, creating a center point to facilitate aiming at a specific object. Certain reticles can also be used to measure distance.

RIFLESCOPE LIMITED LIFETIME WARRANTY

(Within USA and Canada only)

This warranty does not cover consumer-caused damages, abuse, normal wear-and-tear and unauthorized repairs or modifications. For further detailed information, please refer to the warranty policy enclosed with products.

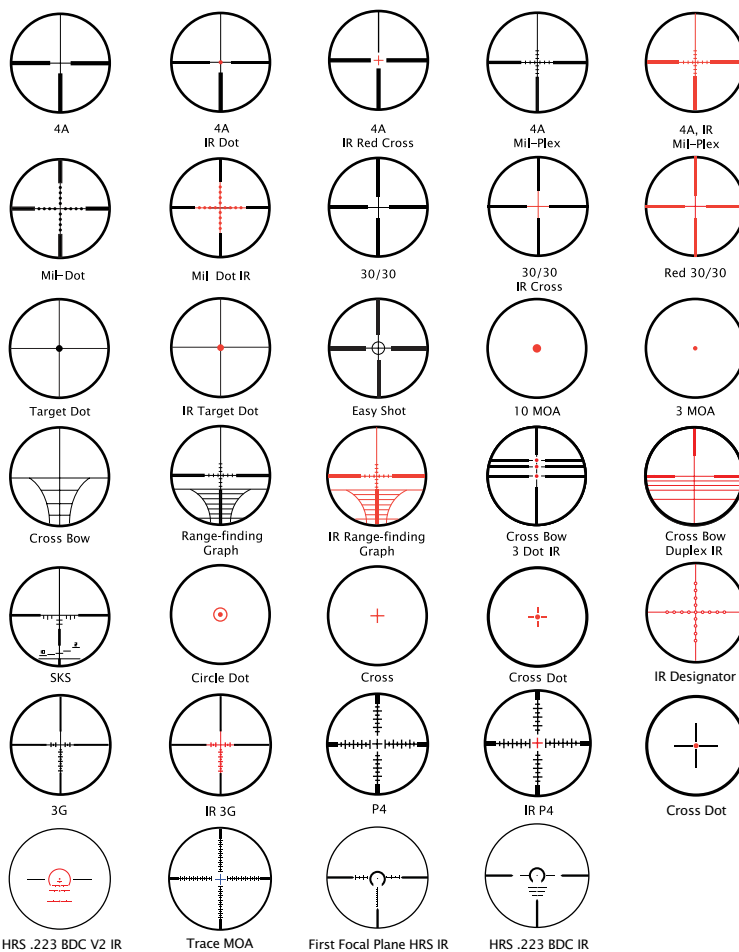



 **6-24x56**
AC12786



 **4-16x50**
AC12784

LEVEL™

Experience the next level of optical performance with the Level Series of riflescopes from Barska. These precision-engineered scopes make targeting easier with the help of an illuminated red and green MOA reticle. A side-mounted rheostat allows the user to quickly adjust the color and brightness of the MOA reticle to better match the current environmental lighting situation. The external windage and elevation knobs allow for precise adjustments and can be locked into place to prevent any unintentional movement. Level rifle scopes feature fully multi-coated optics that deliver outstanding clarity in any environment.

Level Scope Features

Waterproof and fogproof | Extra rigid shockproof construction | Fully multi-coated optics | Illuminated red and green MOA reticle | Adjustable reticle brightness | 30mm tube construction | Easy-grip external windage and elevation adjustments | 1/4 MOA click adjustments | Side adjustable parallax | Precise and easy-to-use for tactical environments | Fast focus eyepiece | Includes mounting rings, sunshade and scope caps | Limited Lifetime Warranty



 **1.5-6x44**
AC12780

Model #	Magnification	Objective Lens (mm)	Reticle	Field of View (ft@100yds/m@100m)	Exit Pupil (mm)	Eye Relief (inch)	Click Value	Tube Diameter	Finish	Weight (oz)	Length (inch)
AC12786	6-24x	56	MOA	16/4.87@6x, 4/1.21@24x	2.3-9.3	3.8	1/4	30mm	Black Matte	31.2	14.6
AC12784	4-16x	50	MOA	24/7.31@4x, 6/1.82@16x	3.1-12.5	4.3	1/4	30mm	Black Matte	28	14
AC12780	1.5-6x	44	MOA	63.5/19.35@1.5x, 15.9/4.84@6x	7.3-29.3	3.5	1/4	30mm	Black Matte	25.6	12.4



LEVEL HD™

Give your rifle a huge boost in accuracy with these Level HD riflescopes. A solid monotube construction helps protect the internal optics from shock and impact, and are built to withstand recoil from AR-15 sporting rifles up to large caliber hunting rifles. Level HD Rifle Scopes are purged with argon gas to prevent internal fogging, even in extremely cold weather, and are coated with phase 3 hard anodizing to prevent scratching. The illuminated reticle can also be switched to either a red or green reticle with adjustable brightness settings for accurate targeting in any lighting situation with impressive viewing clarity. The external windage and elevation knobs allow for precise adjustments and can be locked into place to prevent any unintentional movement. Premium fully multi-coated optics that deliver outstanding clarity in any environment.

Level HD Scope Features

24mm Objective Lens | Waterproof and fogproof | Extra rigid shockproof construction | Premium fully multi-coated optics | Illuminated red and green reticle | Adjustable reticle brightness | 30mm tube construction | Lockable easy-grip external windage and elevation adjustments | 1/2 MOA click adjustments | Side adjustable parallax | Precise and easy-to-use for tactical environments | Fast focus eyepiece | Includes protective scope caps | Limited Lifetime Warranty



1-6x24 IR
AC13026

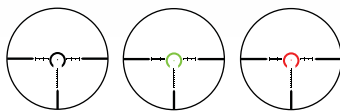

First Focal Plane HRS IR Reticle



1-4x24 IR
AC12798

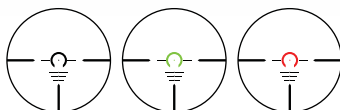

HRS .223 BDC IR Reticle

Model #	Magnification	Objective Lens (mm)	Reticle	Field of View (ft@100yds/m@100m)	Exit Pupil (mm)	Eye Relief (inch)	Click Value	Tube Diameter	Finish	Weight (oz.)	Length (inch)
AC13026	1-6x	24	FFP HRS IR	113.9@1x, 18.8@6x	3.5 - 8	3.9	1/2	30mm	Black Matte	20	10.5
AC12798	1-4x	24	HRS .223 BDC IR	22.9@1x, 5.88@4x	4.76	4.76	1/2	30mm	Black Matte	17.6	9.84

SWAT-AR

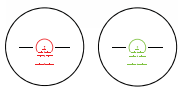

1-8x24 IR
AC13326

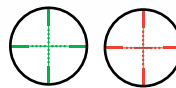

1-4x28 IR
AC11872

The SWAT-AR riflescopes are specifically designed for tactical AR rifles such as the M4 and AR-15 carbine rifles. With the included cantilever AR mount these scopes mount low and ideally forward of the AR's charging handle. The SWAT-AR external windage and elevation turrets. The glass-etched reticle illuminates from black to either red (for low light targeting) and green (for daylight targeting).

Compact SWAT-AR Features

External windage and elevation | Red/green illuminated reticle | Adjustable rheostat | Fully multi-coated optics | CO2 dry nitrogen purged and o-ring sealed for waterproof/fogproof protection | Shockproof high impact rated design to withstand repeated abuse in rugged shooting conditions | Powered by one CR 2032 3V lithium battery (included) | Includes dual cantilever ring scope mount and protective scope caps

Model #	Magnification	Objective Lens (mm)	Reticle	Field of View (ft@100yds/m@100m)	Exit Pupil (mm)	Eye Relief (inch)	Click Value	Tube Diameter	Finish	Weight (oz.)	Length (inch)
AC13326	1-8x	24	HRS .223 BDC V2 IR	103/34@1x, 13/4@8x	8-3	3.6-3.4	1/2	30mm	Black Matte	16.8	11
AC11872	1-4x	28	Dual Mil Dot IR	90/30@1x, 22.5/7.5@4x	15 - 7	4.5	1/2	30mm	Black Matte	16	10

The Blackhawk Rifle Scope Series by Barska that have been designed specifically for long distance targeting. Whether hunting or target shooting, the new Blackhawk Rifle Scopes deliver pinpoint accuracy shot after shot, and have been designed to handle the recoil of larger caliber hunting rifles.

Each scope in this series comes equipped with a red and green illuminated reticle, which allows the user to select the optimal reticle and brightness for the current environment. The green illuminated reticle is ideal for daylight targeting while the red illuminated reticle provides superior targeting in low light environments. The variable magnification on these scopes allows the user to quickly set a magnification that's appropriate for the target distance, allowing for more precise shots on the target. The Barska Blackhawk Rifle Scopes are waterproof, fogproof, and shockproof. Includes a pair of mounting rings and scopes caps. Backed by Barska's Limited Lifetime Rifle Scope Warranty.

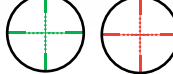

6-24x50 AO IR 
AC12464

External turrets that can be locked securely to prevent movement of the scopes windage and elevation | Adjustable Objective (AO) for parallax correction. For long-range targeting turn the objective lens to focus on distant targets | Includes mounting rings



4-16x40 AO IR 
AC12453

External turrets that can be locked securely to prevent movement of the scopes windage and elevation | Adjustable Objective (AO) for parallax correction. For long-range targeting turn the objective lens to focus on distant targets | Includes mounting rings



3-12x50 IR 
AC12462

The built-in sniper edged sun-shade is set back in the housing to allow the sun shade to cast a shadow and reduce glare for use in bright sunlight. Which gives the rifle scope a great look on any long range rifle or AR combat rifle | Includes mounting rings



3-9x32 IR 
AC12451

The built-in sniper edged sun-shade is set back in the housing to allow the sun shade to cast a shadow and reduce glare for use in bright sunlight. Which gives the rifle scope a great look on any long range rifle or AR combat rifle | Includes mounting rings



2-7x32 IR 
AC12449

The built-in sniper edged sun-shade is set back in the housing to allow the sun shade to cast a shadow and reduce glare for use in bright sunlight. Which gives the rifle scope a great look on any long range rifle or AR combat rifle | Includes mounting rings

Model #	Magnification	Objective Lens (mm)	Reticle	Field of View (ft@100yds/m@100m)	Exit Pupil (mm)	Eye Relief (inch)	Click Value	Tube Diameter	Finish	Weight (oz.)	Length (inch)
AC12464	6-24x	50	Mil-Dot	13.88/4.23@6x, 4.13/1.25@24x	8.3-2.1	4.01-3.03	1/4	1"	Black Matte	20.2	15.25
AC12453	4-16x	40	Mil-Dot	24.8/8.27@4x, 6.2/2.07@16x	10-2.5	3.3-3.1	1/4	1"	Black Matte	17.6	14.8
AC12462	3-12x	50	Mil-Dot	28/8.53@3x, 7/2.1@12x	8-4	3.5-3.4	1/4	1"	Black Matte	15.9	14.2
AC12451	3-9x	32	Mil-Dot	39.3/13.1@3x, 13.1/4.37@9x	10-3.6	3.3-3.1	1/4	1"	Black Matte	12.6	12.7
AC12449	2-7x	32	Mil-Dot	49/16.33@2x, 14/4.67@7x	15-8	4.4-4.3	1/4	1"	Black Matte	12.4	11.4



AR6 | Rifle scope

The AR6 Riflescopes by Barska is a highly developed large caliber scope. The AR6 scopes was developed by the demand of shooters of mid to large caliber rifles. The 6x magnification technology of these scopes allows a wider magnification range of intervals of 6x. The Barska AR6 scopes are waterproof, fogproof and shockproof and are backed by the Barska Limited Lifetime Rifle scope Warranty.

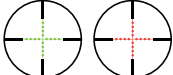
 **1-6x24 IR**
AC12390



Compact in size | Green and red mil-dot IR reticle | 30mm tube | Includes dual cantilever ring scope mount and flip up scope caps



Capped windage and elevation turrets that help prevent any unintentional changes to the settings | 1/2 MOA click adjustments

 **2.5-15x56**
AC11584



Wide field of view | Accu-lock stabilizing system | High impact rated | Fully multi-coated optics | Built to withstand the most punishing large caliber rifles | Mil-dot reticle | 1-inch mono tube | Includes flip-up scope caps



Capped windage and elevation turrets that help prevent any unintentional adjustments to the settings | 1/4 MOA click adjustments | Side parallax adjustment

Model #	Magnification	Objective Lens (mm)	Reticle	Field of View (ft@100yds/m@100m)	Exit Pupil (mm)	Eye Relief (inch)	Click Value	Tube Diameter	Finish	Weight (oz.)	Length (in)
AC11584	2.5-15x	56	Mil-Dot	12.4/37.20 @2.5x, 2.1/6.28@15x	13.2 - 3.5	3.7	1/4	1"	Black Matte	24	13.75
AC12390	1-6x	24	Dual Mil-Dot IR	75.78/23.1 @1x, 12.79/3.9 @6x	11-4	3.7	1/2	30mm	Black Matte	24.8	11.5

SWAT | Extreme Tactical Rifle Scope Series

The 3rd generation SWAT series of extreme tactical scopes offers outstanding performance, impressive features and rugged construction making them an unbeatable value. BARSKA SWAT scopes include an illuminated glass etched Mil-Dot reticle with variable brightness settings. Precision adjustments and focusing are achieved with a fast focus eyepiece, fast access zoom magnification ring, external easy-grip target-style lockable windage and elevation turrets and a side turret-mounted parallax adjustment. With its hair-splitting accuracy and impressive fully multi-coated optics, SWAT is ideal for varmint and long-range shooting. Built to operate under the most demanding conditions, SWAT performs brilliantly in extremely low or high temperature conditions. SWAT scopes include a set of 5/8" high see-through rings as well as a 5" sunshade to protect against glare and flip-up lens covers to protect the lenses from dirt or dust. SWAT scopes are backed by BARSKA's Limited Lifetime Warranty.



3rd Generation Lockable Windage and Elevation Adjustments

Lockable easy-grip target-style windage and elevation adjustments designed with audible, tactile "clicks" for precision.



Side Parallax Adjustments

Allows fine adjustment of parallax correction for specific ranges using the turret-mounted focus knob, without taking your eyes off the target.

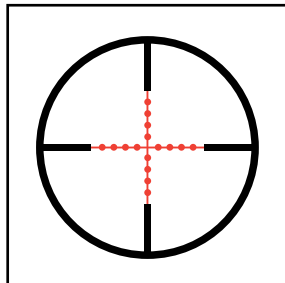

Illuminated Glass-Etched Mil-Dot Reticle

The glass-etched mil-dot ensures accuracy and precision. Featuring an illuminated technology with an adjustable rheostat of 11 settings for low light targeting.



Accessories Included

Includes set of 5/8" high see-through tactical rings, 5" sun shade to create custom length and to protect against glare and flip-up scope caps.



6-24x60 IR
AC10700
Includes rings, sunshade and flip-up caps



10-40x50 IR
AC10550
Includes rings, sunshade and flip-up caps



6-24x44 IR
AC10366
Includes rings, sunshade and flip-up caps



3.5-10x40 IR
AC10814
Includes rings, sunshade and flip-up caps

SWAT Scope Features

Waterproof and fogproof | Extra rigid shockproof construction | Fully multi-coated optics | Illuminated mil-dot glass-etched reticle | 30mm monotube construction for maximum light gathering | Lockable easy-grip target-style windage and elevation adjustments | 1/8 or 1/4 MOA click adjustments | Side adjustable parallax | Precise and easy-to-use for tactical environments | Fast focus eyepiece | Limited Lifetime Warranty

Model #	Magnification	Objective Lens (mm)	Reticle	Field of View (ft@100yds/m@100m)	Exit Pupil (mm)	Eye Relief (inch)	Click Value	Tube Diameter	Finish	Weight (oz.)	Length (inch)
AC10700	6-24x	60	Mil Dot IR	15/5@6x, 4.2/1.4@24x	10-2.5	3.5	1/8	30mm	Black Matte	28.9	16
AC10550	10-40x	50	Mil Dot IR	9.4/3.1@10x, 2.6/0.9@40x	5.0-1.3	3.6	1/8	30mm	Black Matte	31.4	15.7
AC10366	6-24x	44	Mil Dot IR	15/5@6x, 4.2/1.4@24x	7.3-1.83	3.5	1/8	30mm	Black Matte	24	16
AC10814	3.5-10x	40	Mil Dot IR	29.3/9.8@3.5x, 9.4/3.1@10x	11.43-4	3.3	1/4	30mm	Black Matte	24.16	14.5

BENCHMARK | Extreme Long Distance Rifle Scope Series



8-26x50
AC11198

· First Focal Plane
Mil-Dot Reticle



5-20x50
AC11200

· First Focal Plane
Mil-Dot Reticle



4-16x50
AC11202

· First Focal Plane
Mil-Dot Reticle

Accuracy, durability and exceptional optical quality are hallmarks of the Benchmark rifle scope series. The Benchmark's Mil-Dot Reticle is on the first focal plane which means that it tracks proportionally throughout the power ranges no matter what power you have the scope on. You can mil, hold over, hold off or do anything that requires an accurate measurement without worrying about the scope's power setting. Available in zoom or fixed power each Benchmark model is waterproof, fogproof and shockproof and features fully multi-coated optics for sharp distortion-free views. Backed by BARSKA's Limited Lifetime Warranty.

Benchmark Features

Mil-dot reticle / First focal plane | Accu lock | Side focus adjustable objective | Fully multi-coated optics | 1/8 MOA | Parallax-free @ 50 yd. | 30mm tube diameter | Includes 3" shade to create custom length and to protect against glare | Limited Lifetime Warranty

First Focal Plane Mil-Dot Reticle

Allows you to use the rangefinding capability of the Mil-Dot reticle at all magnifications. Select models

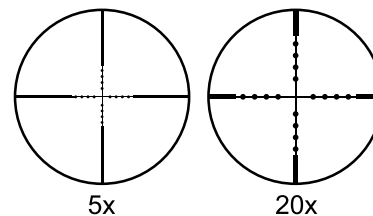

Side Parallax Adjustments

Allows fine adjustment on parallax correction for specific ranges using the turret-mounted focus knob without taking your eyes off the target.



"ACCU-LOCK"

BARSKA's Accu-Lock system utilizes a coil spring positioned within the scope to securely lock the inner tube. This coil positioning system allows the scope to stay locked dead-on to the target shot after shot.



Model #	Magnification	Objective Lens (mm)	Reticle	Field of View (ft@100yds/m@100m)	Exit Pupil (mm)	Eye Relief (inch)	Click Value	Tube Diameter	Finish	Weight (oz.)	Length (inch)
AC11198	8-26x	50	Mil-Dot	15.2/5.07@8x, 3.67/1.22@26x	8-2	2.7	1/8	30mm	Black Matte	27.86	17.63
AC11200	5-20x	50	Mil-Dot	20.97/5.43@5x, 5.23/1.74@20x	10-2.5	2.8	1/8	30mm	Black Matte	26.8	16.02
AC11202	4-16x	50	Mil-Dot	22.56/7.52@4x, 5.76/1.92@16x	12.5-3.5	4.8	1/8	30mm	Black Matte	25.74	16.14

SNIPER | Rifle Scope Series

Sniper scopes are designed for high-resolution sighting of distant targets where precision is an absolute necessity. Windage/elevation adjustments are performed by moving the external target style turrets. After the scope is adjusted to your specific shooting distance you can then re-zero the turret charts, a small screw at the top-side of the turret can be loosened and the chart can be reset to zero. The multi-coated lenses are flawless with perfect clarity for distant viewing and sighting of still and moving objects and also protect against the sun's UV rays, and enhance light transmission. Sniper scopes are used in hunting and varmint hunting situations where targets must be sighted at a distant great enough to prevent danger to the hunter. In each of these settings the scopes have proven to be accurate and rugged in the harshest conditions.

Sniper Scope Features

Waterproof and fogproof | Extra rigid shockproof construction | Multi-Coated optics | Illuminated red and green mil-dot reticles | 30mm or 1" tube construction | Easy-grip target-style windage and elevation adjustments | 1/8 or 1/4 MOA click adjustments | Side adjustable parallax (select models) | Precise and easy-to-use for tactical environments | Fast focus eyepiece | Includes protective scope caps and set of rings | Limited Lifetime Warranty



Snipers Edge

The built-in sniper edged sun-shade is set back in the housing to allow the sun shade to cast a shadow and reduce glare for use in bright sun. Which gives the riflescope a great look on any long range rifle or AR combat rifle.



Side Parallax Adjustments

Select models feature a side focus which allows fine adjustment on parallax correction for specific ranges using the turret-mounted focus knob without taking your eyes off the target.



Dual Color Mil-Dot Reticle

Depending on the lighting conditions the mil-dot reticle can be switched on from red to green and back to black. Green is ideal in the day time or low light situations.

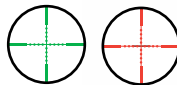

10-40x50 IR
AC11674
Side Parallax Adjustment

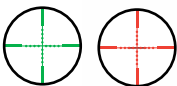

6-24x50 IR
AC11672
Side Parallax Adjustment

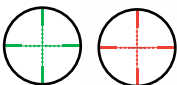

4-16x50 IR
AC11670

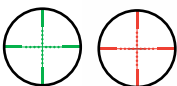

3-9x42 IR
AC11668

Model #	Magnification	Objective Lens (mm)	Reticle	Field of View (ft@100yds/m@100m)	Exit Pupil (mm)	Eye Relief (inch)	Click Value	Tube Diameter	Finish	Weight (oz.)	Length (inch)
AC11674	10-40x	50	Mil Dot IR Dual Color	9.94/3.31@10x, 2.5/.83@40x	5-1.3	3.15	1/8	30mm	Black Matte	29.6	17.5
AC11672	6-24x	50	Mil Dot IR Dual Color	15.7/5.2@6x, 3.94/1.3@24x	8.3-2.1	3.15	1/8	30mm	Black Matte	24.8	16
AC11670	4-16x	50	Mil Dot IR Dual Color	19.9/6.6@4x, 5.8/1.9@16x	12.5-3.1	3.1	1/8	30mm	Black Matte	23.2	14.5
AC11668	3-9x	42	Mil Dot IR Dual Color	35.1/11.7@3x, 12.5/4.2@9x	14-4.69	3.9	1/4	1"	Black Matte	20	10

TACTICAL | First Focal Plane Tactical Riflescope Series

Maximum control and accuracy shot after shot. BARSKA tactical scopes are designed to give you as much control as possible for extreme type shooting. Select models are designed with features like side adjustable parallax and a first focal plane Mil-Dot reticle that allows you to estimate range at all power settings. Tactical scopes also include our Accu-Lock system. BARSKA's Accu-Lock system utilizes a coil spring positioned within the scope to securely lock the inner tube. This coil positioning system allows the scope to stay locked dead-on to the target shot after shot. Rugged and waterproof, you're always on target with BARSKA's Tactical scopes.

Tactical Features

Long range / tactical scope | Accu-lock technology | Side adjustable parallax setting | Strong high grade alloy construction monotube | Illuminated mil-dot glass etched reticle | First focal plane reticle to estimate range at any magnification | Waterproof and fogproof | Extra-rigid shockproof construction | Fast focus eyepiece | Windage and elevation adjustments | Fully multi-coated optics | Includes pair of rings and scope caps | Limited Lifetime Warranty



First Focal Plane Mil-Dot Reticles

Allows you to estimate range at all different magnification settings. With the reticle at first focal plane, the reticle expands as the magnification increases. This creates dead-on precision and accuracy.

Side Parallax Adjustments

Allows fine adjustment on parallax correction for specific ranges using the turret-mounted focus knob without taking your eyes off the target.

"ACCU-LOCK"

BARSKA's Accu-Lock system utilizes a coil spring positioned within the scope to securely lock the inner tube. This coil positioning system allows the scope to stay locked dead-on to the target shot after shot.



4-16x50 IR
AC13348



6.5-20x40 IR
AC10778

Model #	Magnification	Objective Lens (mm)	Reticle	Field of View (ft@100yds/m@100m)	Exit Pupil (mm)	Eye Relief (inch)	Click Value	Tube Diameter	Finish	Weight (oz.)	Length (inch)
AC10778	6.5-20x	40	Mil Dot IR	15.5/5.2@6.5x, 5/1.7@20x	6.2-2	3.2	1/4	1"	Black Matte	21.87	16.0
AC13348	4-16x	50	Trace MOA IR	24.63/8.23@4x, 6.23/2.1@16x	3.1-12.5	4.8-3.4	1/4	30mm	Black Matte	26	13

POINT BLACK | .223 B.D.C. Rifle Scope Series



6-24x40 IR
AC11392



4-16x40 IR
AC11390



3-12x40 IR
AC11388



3-9x40
AC11386



2-7x32
AC11384

Point Black Features

.223 Multi-grain B.D.C elevation adjustment | Accu-lock technology | Side adjustable parallax setting | Strong 1" monotube construction | Green, red and blue illuminated 3G Glass Etched Reticle (select models) | Waterproof and fogproof | High impact rated shockproof construction | Fast focus eyepiece | Easy grip target-style windage and elevation adjustments | Fully multi-coated optics | Flip-up scope caps included | Limited Lifetime Warranty



BARSKA's Point Black series is specifically engineered for the .223 caliber bullet with a multi-grain bullet drop compensation chart (B.D.C) on the exterior elevation knob. The multi-grain B.D.C features three common med to heavy weight .223 bullet grains: 50 grain, 55 grain and 62 grain. The Point Black series of riflescopes are engineered to be versatile full featured riflescopes to be utilized with the large selection of firearms that chamber the high velocity .223 bullet. Point Black riflescopes work in perfect combination with such firearms as varmint rifles, bolt action rifles, semi-automatic rifles, AR-15 / M-16 assault rifles, Mini-14 and ranch rifles.

Point Black riflescopes also feature impressive fully multi-coated optics, high impact rated shockproof construction, side parallax adjustment, variable low to high power zoom magnification and a precision 3G reticle. The riflescopes 1" inch main tube features a shockproof high impact rated design to withstand repeated abuse in rugged shooting conditions. All Point Black scopes are CO₂ dry nitrogen purged and o-ring sealed for waterproof / fogproof protection. Point Black scopes include lens covers, flip-up scope caps and are backed by BARSKA's Limited Lifetime Warranty.

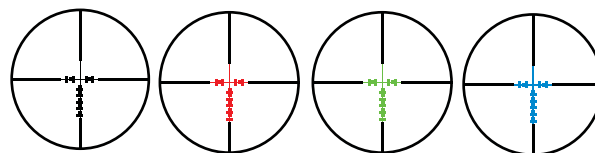

3G Glass Etched Reticle: Three of the five models feature a center lit green, red and blue 3G illuminated glass etched reticle for low light targeting.

.223 Multi-Grain B.D.C Elevation

Multi-grain bullet drop compensation chart features three common med to heavy weight .223 bullet grains: 50 grain, 55 grain and 62 grain.



Side Parallax Adjustments

Allows fine adjustment of parallax correction for specific ranges using the turret-mounted focus knob, without taking your eyes off the target.

Model #	Magnification	Objective Lens (mm)	Reticle	Field of View (ft@100yds/m@100m)	Exit Pupil (mm)	Eye Relief (inch)	Click Value	Tube Diameter	Finish	Weight (oz.)	Length (inch)
AC11392	6-24x	40	3G IR	17.3/5.8, 4.2/1.4	6.6-1.6	3.93	1/8	1"	Black Matte	21.89	14.25
AC11390	4-16x	40	3G IR	24.6/8.2, 6.3/2.1	10-2.5	3.93	1/8	1"	Black Matte	21.16	12.5
AC11386	3-9x	40	3G	33/11, 11/3.7	13.3-4.4	3.93	1/4	1"	Black Matte	21.16	12.5
AC11388	3-12x	40	3G IR	33/11, 8.4-2.8	13.3-3.3	3.93	1/4	1"	Black Matte	21.16	12.25
AC11384	2-7x	32	3G	46.6/15.6, 13.1/4.4	16-4.5	3.93	1/4	1"	Black Matte	19.04	11.25

HUNTMASTER PRO | Illuminated Riflescope Series

There's a reason why we call these Huntmaster scopes "Pro". One of the most advanced and feature rich riflescope series that feature a center-lit illuminated 30/30 reticle and illumination is easily adjusted using the convenient rear mounted click stop rheostat with eleven brightness settings. Focusing is quick and precise thanks to a fast focus eyepiece and convenient zoom adjustment and are parallax-free at 100 yards. With large objectives for maximum light gathering, waterproof and fogproof protection and multi-coated optics your view through the scope stays sharp and clear even in low light and poor weather conditions. 1" monotube construction and are engineered to handle the rigors and demands of high power shooting. Includes lens covers and are backed by BARSKA's Limited Lifetime Warranty.

Huntmaster Pro Features

Waterproof, fogproof and shockproof | Large objective lens for increased light transmission | Multi-Coated optics | Sleek, sturdy construction | Parallax-free at 100 yards | Fast focus eyepiece | For low-light and dark backgrounds hunting conditions | Illuminated center-lit reticles | Scope caps included | Limited Lifetime Warranty



Model #	Magnification	Objective Lens (mm)	Reticle	Field of View (ft@100yds/m@100m)	Exit Pupil (mm)	Eye Relief (inch)	Click Value	Tube Diameter	Finish	Weight (oz.)	Length (inch)
AC10056	3-12x	50	30/30 IR Cross	35/11.6@3x, 10/3.3@12x	16.7-4.2	2.7	1/4	1"	Black Matte	21.34	13
AC10054	1.5-6x	42	30/30 IR Cross	44/14.6@1.5x, 16/5.3@6x	28-7	2.7	1/4	1"	Black Matte	18.1	13
AC11310	3-9x	40	30/30 IR Cross	41/13.67@3x, 15/5@9x	13.3-4.4	3	1/4	1"	Black Matte	7.05	12.75

HUNTMASTER | Riflescope Series

Accuracy, precision and dependability at a popular price. Huntmaster has it all. This series is the perfect choice for serious shooters or hunters who want a wealth of features and performance but don't want to spend a fortune. The Huntmaster combines high quality optics and rugged construction with accuracy and ease of use. Huntmaster scopes feature fully-coated optics for bright clear views, rugged 1" monotube construction and are waterproof, fogproof and shockproof. With a variety of reticles available, Huntmasters are suitable for all types of general purpose hunting.

Huntmaster Features

Waterproof, fogproof and shockproof | Fully coated optics | 1" monotube construction | Parallax-free at 100 yards | 1/4 MOA fingertip adjustments | Sleek, sturdy construction | Scope caps included | Limited Lifetime Warranty



Model #	Magnification	Objective Lens (mm)	Reticle	Field of View (ft@100yds/m@100m)	Exit Pupil (mm)	Eye Relief (inch)	Click Value	Tube Diameter	Finish	Weight (oz.)	Length (inch)
AC10034	3-9x	50	30/30	32/10.6@3x, 12/4@9x	16.7-5.6	3.3	1/4	1"	Black Matte	20.1	12.2
AC10032	3-9x	40	Easy Shot	36/12@3x, 14/4.6@9x	13.3-4.4	3.3	1/4	1"	Black Matte	12.9	12.2
AC10030	3-9x	40	30/30	36/12@3x, 14/4.6@9x	13.3-4.4	3.3	1/4	1"	Black Matte	12.9	12.2

HOT MAGNUM | .17 & .22 B.D.C. Rifle Scope Series

Engineered with revolutionary Bullet Drop Technology, these scopes now offer optional bullet drop compensation for .17 and .22. Using an interchangeable .22 BDC turret, you can easily convert from .17 to .22. The scopes .17 and .22 elevation knobs are precisely calibrated to compensate for the elliptical drop of the .17 Magnum rimfire with a 17 grain bullet and .22 caliber bullets. Added features like high density optical glass | Multi-coated optics | Objective adjustable parallax | 1" tube diameter | Includes lens covers | Limited Lifetime Warranty

Hot Magnum Features

- Waterproof and fogproof | 30/30 Reticle | Finger adjustable windage and elevation | Interchangeable .17 and .22 bullet drop turrets | Specifically engineered for .17 and .22 caliber rifles | Pre-calculated trajectory compensation from 100 to 300 yards | High density optical glass | Multi-coated optics | Objective adjustable parallax | 1" tube diameter | Includes lens covers | Limited Lifetime Warranty



Hot Magnum Scopes include interchangeable .22 BDC elevation knobs for 40GR, 38 GR and 36GR .22 bullets.



 **6-18x40 AO**
AC10850



 **3-12x40 AO**
AC10848



 **2-7x32 AO**
AC10846

Model #	Magnification	Objective Lens (mm)	Reticle	Field of View (ft@100yds/m@100m)	Exit Pupil (mm)	Eye Relief (inch)	Click Value	Tube Diameter	Finish	Weight (oz.)	Length (inch)
AC10850	6-18x	40	30/30	14.5/4.8@6x, 4.5/1.5@18x	6.67-2.2	3.1	1/4	1"	Black Matte	20.48	15.65
AC10848	3-12x	40	30/30	26.7/8.9@3x, 7.4/2.5@12x	10.8-3.3	3.1	1/4	1"	Black Matte	18.88	13.75
AC10846	2-7x	32	30/30	45.7/15.2@2x, 14/4.7@7x	10.8-4.6	3.1	1/4	1"	Black Matte	16.64	12.0



The Euro-30 Pro Series combines European design features with world-class engineering to produce a scope that is ideal for big game hunting anywhere on the globe or local general hunting. Featuring three models with a European 4A IR (Illuminated Reticle) that has eleven brightness adjustments. All scopes have 30mm tube construction. The large objective lens sizes and fully coated optics deliver bright clear images even in low light conditions and the scopes are waterproof, fogproof and shockproof. Scopes include a set of 5/8" high see-through rings and lens covers.

Euro-30 Pro Features

Waterproof, fogproof and shockproof | Fully coated optics | 30mm monotube construction for enhanced light gathering | Wider field of view | Parallax-free at 100 yards | 1/4 MOA click adjustments | Fast focus eyepiece | For big game and general hunting | Illuminated 4A European reticle | Scope caps included | Limited Lifetime Warranty

All Euro-30 Pro Scopes include a set of 5/8" high rings



4-16x60 IR
AC11314



3-12x56 IR
AC10024



3-12x50 IR
AC10022

EURO-30 | Riflescope Series

This scope deserves a good look. BARSKA's stylish Euro-30 is a European design wrapped around premium quality performance optics. Euro-30 features a 4A European reticle and solid 30mm monotube construction which provides high recoil capability. With fully coated optics, fast focus eyepiece, wide field of view the Euro-30 rivals traditional 1" scopes. As a bonus, 5/8" rings are included with Euro-30 scopes.

Euro-30 Features

Waterproof, fogproof and shockproof | Fully coated optics | 30mm monotube construction for enhanced light gathering | Wider field of view for quick targeting | Parallax-free at 100 yards | 1/4 MOA click adjustments | Fast focus eyepiece | For big game and general hunting | Scope caps and set of 5/8" high rings included | Limited Lifetime Warranty



3-9x42
AC10014
Includes 5/8" High Rings

Euro-30 scopes include a set of 5/8" high rings



1.25-4.5x26
AC10018
Includes 5/8" High Rings



Model #	Magnification	Objective Lens (mm)	Reticle	Field of View (ft@100yds/m@100m)	Exit Pupil (mm)	Eye Relief (inch)	Click Value	Tube Diameter	Finish	Weight (oz.)	Length (inch)
AC11314	4-16x	60	4A, IR Cross	23.6/7.87@4x, 6.28/2.09@16x	15-3.75	3.34-3.62	1/4	30mm	Black Matte	28.2	14.5
AC10024	3-12x	56	4A, IR Cross	35/11.6@3x, 10/3.3@12x	18.7-4.7	3.5	1/4	30mm	Black Matte	24.8	13
AC10022	3-12x	50	4A, IR Dot	35.2/11.7@3x, 10.3/3.4@12x	16.8-4.2	3.3	1/4	30mm	Black Matte	21.5	13.2
AC10014	3-9x	42	4A	38/12.6@3x, 13/4.3@9x	14-4.7	3.3	1/4	30mm	Black Matte	16.9	12.6
AC10018	1.25-4.5x	26	4A	82/27.3@1.25x, 30/10@4.5x	20.8-5.8	3	1/4	30mm	Black Matte	15.2	10.8

VARMINT | Long-Range Riflescope Series

The Varmint riflescope series is one of our most versatile and is available in a wide selection of sizes and reticles for many types of shooting including varmint hunting, target shooting, long range and precision shooting. Select Varmints scope feature an Adjustable Objective (AO) for long-range targeting turn the objective lens to focus on distant targets. and unsurpassed accuracy as well as easy-grip extra high windage and elevation turrets. The Varmint's large objective lens size coupled with multi-coated optics increases light transmission and provides superior clarity. In addition, Varmints are available with a variety of reticle types including 30/30, Mil-Dot, Target and Rangefinder. Waterproof, shockproof and fogproof, BARSKA's Varmint Series is like having many scopes in one. Includes lens covers and are backed by BARSKA's Limited Lifetime Warranty.

Varmint Features

Waterproof, fogproof and shockproof | Fully multi-coated and multi optics for clear images | 1" tube construction | Adjustable objective lens to adjust for parallax (select models) | 1/8 and 1/4 MOA fingertip adjustments (select models) | Large objective lens for increased light transmission | Quick access magnification zoom ring | Designed for long-range and shooting | Scope caps Included | Limited Lifetime Warranty



10-40x50 AO
AC11084



6-24x50 AO
AC10050

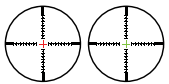

5-20x50 IR
AC13356

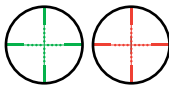

3-12x44 AO IR
AC13544



4-16x40 AO
AC10832



6.5-20x50 AO
AC10048



4-16x50 AO
AC10042



6-24x42 AO
AC10046

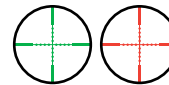

4-16x40 AO IR
AC13546

Model #	Magnification	Objective Lens (mm)	Reticle	Field of View (ft@100yds/m@100m)	Exit Pupil (mm)	Eye Relief (inch)	Click Value	Tube Diameter	Finish	Weight (oz)	Length (inch)
AC13524	10-40x	60	Trace MOA	9.42/3.14@10x, 2.35/0.78@40x	6.3-1.5	3.6	1/8	30mm	Black Matte	30.4	17
AC11084	10-40x	50	Mil Dot	9.42/3.14@10x, 2.62/0.87@40x	5-1.25	3.6	1/8	1"	Black Matte	20.53	16.53
AC10050	6-24x	50	Mil Dot	15/5@6x, 4.2/1.4@24x	8.3-2.0	3.5	1/8	1"	Black Matte	21.98	16.42
AC10048	6.5-20x	50	Target Dot	16/5.3@6.5x, 5.7/1.9@20x	7.7-2.5	3.6	1/8	1"	Black Matte	22.3	15.95
AC13356	5-20x	50	Trace MOA IR	21.4/7.1@5x, 6.8/2.2@20x	2.5-10	3	1/4	30mm	Black Matte	21	14
AC10042	4-16x	50	30/30	19/6.6@4x, 5.8/1.9@16x	12.5-3.1	3.5	1/8	1"	Black Matte	21	14.57
AC13544	3-12x	44	Mil Dot IR	25.18/4.81@3x, 7.33/1.40@12x	11.36-3.3	3.15	1/4	30mm	Black Matte	25	13.63
AC10046	6-24x	42	Mil Dot	15/5@6x, 4.2/1.4@24x	7-1.75	3.5	1/8	1"	Black Matte	20.46	15.7
AC10832	4-16x	40	30/30	19.9/6.6@4x, 5.8/1.9@16x	10-2.5	3.3	1/8	1"	Black Matte	19.05	14.57
AC13546	4-16x	40	Mil Dot IR	20.94/4 @4x, 5.75/1.1@16x	8.7-2.53	2.80	1/8	24.5	Black Matte	22.4	15.13

CONTOUR | Compact Scope Series



Contour Features

A variety of compact scopes and reticles for various types of shooting | Ideal for crossbows, pistols, shotguns and more | Extremely long eye relief (select models) | Waterproof and fogproof protection | Fully coated optics | Compact in size | Extra rigid shockproof construction | A variety of reticles | Scope caps included | Limited Lifetime Warranty



4x32 w/ SKS Base and Rings
AC10882

- Includes SKS Mount and 7/8" Rings



4x32 IR
AC11876, AC11877 Clam

- Built-in sniper edged sun-shade
- Red / green illuminated mil-dot reticle
- Includes flip up covers and a set of 7/8" picatinny/weaver style rings

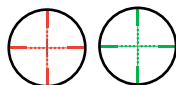

4x32 Camo
AC12184, AC12185 Clam

- Engineered specifically for crossbow
- Multiple aiming point crossbow reticle
- Extreme long eye relief of 5.8"
- Mossy-Oak® Break-Up® camo

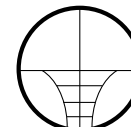

Crossbow Reticle



4x32
AC12182, AC12183 Clam

- Engineered specifically for crossbow
- Multiple aiming point crossbow reticle
- Extreme long eye relief of 5.8"

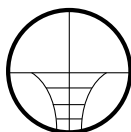

2x20, Long Eye Relief
AC12178



Model #	Magnification	Objective Lens (mm)	Reticle	Field of View (ft@100yds/m@100m)	Exit Pupil (mm)	Eye Relief (Inch)	Click Value	Tube Diameter	Finish	Weight (oz.)	Length (Inch)
AC11326	3-9x	40	4A, Mil-plex IR	12.5@3x, 37.7@9x	13.3-4.4	3	1/2	30mm	Black Matte	14.81	8
AC11876	4x	32	Mil Dot IR, Dual Color	31.5/10.5	8	3.3	1/4	1"	Black Matte	10.4	8.25
AC10882	4x	32	30/30	23.57/7.86	8	3.35	1/4	1"	Black Matte	8.29	7.48
AC12184	4x	32	Crossbow	26.1/8.7	8	5.8	1/4	1"	Camo	9.2	9
AC12178	2x	20	30/30	10.47/3.19	9.5	11.8	1/2	1"	Black Matte	6.6	8.5



3-9x42 IR
AC13268

- Elastic rubber glare reducing finish
- External windage and elevation
- Red / green / blue illuminated Trace MOA reticle



Performance that doesn't stop short. BARSKA's Contour series meets the hunter's demands by combining performance and innovation in a compact rifle scope without sacrificing ruggedness, dependability and craftsmanship. Contour scopes offer low magnification combined with long eye relief making them ideal for close range action – from cross-bow hunting to pistol shooting even down to simple rimfire action. Contours are engineered with extra rigid shockproof construction to handle the demands of pistols, shotguns and other types of high recoil firearms. This series is a clear winner for various types of shooters and hunters in the field.



3-9x42 IR
AC10552

- Red / green illuminated 30/30 mil-dot reticle
- 5-position brightness intensity for each color.
- Includes a set of 7/8" picatinny/weaver style rings

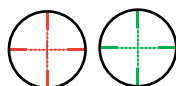

3-9x42 IR
AC10634

- Range and trajectory adjustment
- Range drum rotates for desired range
- Includes a set of 7/8" picatinny/weaver style rings



3-9x42 IR
AC11422

- Lockable external windage and elevation
- Side mounted red / green illuminated mil-dot reticle
- Includes a set of 7/8" picatinny/weaver style rings

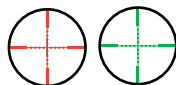

3-9x42 IR
AC12468

- External windage and elevation
- Side mounted red / green illuminated mil-dot reticle
- Built in ring and top rail accessory

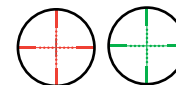

Model #	Magnification	Objective Lens (mm)	Reticle	Field of View (ft@100yds/m@100m)	Exit Pupil (mm)	Eye Relief (inch)	Click Value	Tube Diameter	Finish	Weight (oz.)	Length (inch)
AC13268	3-9x	42	Trace MOA IR	18.6/6.2@3x, 6.72/2.24@9x	14-4.6	4.33-5.43	1/4	30mm	Black Matte	21.6	9.75
AC10552	3-9x	42	30/30 IR	36.7/12.3@3x, 12.5/4.2@9x	4.5	3.9	1/4	1"	Black Matte	16	9.13
AC10634	3-9x	42	4A, Mil-Plex IR	36.7/12.3@3x, 12.5/4.2@9x	14.0-4.6	3.9	1/4	1"	Black Matte	16	9.8
AC11422	3-9x	42	Mil Dot IR, Dual Color	18.6/6.2@3x, 6.72/2.24@9x	14-4.6	4.33-5.43	1/4	1"	Black Matte	17.46	9
AC12468	3-9x	42	Mil Dot	37.88/11.54@3x, 11.52/3.5@9x	3.3-1.7	4.1-8.1	1/4	1"	Black Matte	16	8

AIR GUN | Air Rifle Scope Series

The Air Gun series is designed to withstand the extraordinary punishing recoil energy generated by air guns. BARSKA's Air Gun series features multi-range parallax setting adjustments and a Mil-Dot reticle. Fully coated optics and feature an adjustable objective that corrects for parallax allows these scopes to deliver the accuracy and precision you need shot after shot. Waterproof, fogproof and shockproof, the Air Gun scopes are ideal for competition and recreational shooting.

Air Gun Features

Waterproof, fogproof and shockproof | Fully coated optics | 1" tube construction | Adjustable objective lens to adjust for parallax | 1/4 MOA fingertip adjustments | Designed to withstand the punishing recoil energy of air guns | Mil-Dot reticle | Scope caps included | Limited Lifetime Warranty



 **3-12x40 AO**
AC10008

 **3-12x40 AO**
AC12676

 **2-7x32 AO**
AC10006

 **4x32 AO**
AC10004

Plinker-22 | Rifle Scope Series

The Plinker-22 series is engineered specifically for your .22 rifles and rimfires to provide striking performance. Made for plinking and general hunting, these scopes offer bright clear optics and the durability of scopes costing significantly more. We even provide the 3/8" rings as a bonus. Built to withstand the rough outdoors, the Plinker-22 is waterproof, fogproof and shockproof. With fully coated optics, a 30/30 reticle, included 3/8" dovetail rings and scope caps.

Plinker-22 Features

Waterproof, fogproof and shockproof | Fully coated optics | 1" monotube construction (select models) | Parallax-free at 50 yards | 1/4 MOA fingertip adjustments | For general hunting and plinking | 3/8" dovetail rings | 30/30 reticle | Scope caps included | Limited Lifetime Warranty



 **4x32**
AC13490

 **4x32**
AC10040

 **4x32 IR**
AC10037 Clam

 **4x32**
AC10038
AC10039 Clam

 **3-9x32**
AC10380

Rimfire | Rifle Scope Series

BARSKA's Rimfire series are calibrated parallax-free at 50 yards for shorter rimfire ranges. Featuring coated optics and a 30/30 reticle, Rimfire scopes are ideal for competitive and recreational target shooting, small game or varmint-type hunting.

Rimfire Features

Coated optics | Parallax-free at 50 yards | 1/4" MOA coin adjustments | Standard 3/8" rings included | 30/30 reticle | Limited Lifetime Warranty



 **3-7x20**
AC10002

 **4x20**
AC10730

 **4x15**
AC10000

Model #	Magnification	Objective Lens (mm)	Reticle	Field of View (ft@100yds/m@100m)	Exit Pupil (mm)	Eye Relief (inch)	Click Value	Tube Diameter	Finish	Weight (oz.)	Length (inch)
AC10008	3-12x	40	Mil Dot	35/11.6@3x, 9/3@12x	13.3-3.3	4.2	1/4	1"	Black Matte	18.1	13.66
AC10006	2-7x	32	Mil Dot	57/19@2x, 17/5.6@7x	16-4.6	3.5	1/4	1"	Black Matte	15.52	11.66
AC10004	4x	32	Mil Dot	29/9.3@4x	8.0	3.3	1/4	1"	Black Matte	13.54	11.93
AC10380	3-9x	32	30/30	36/13@3x, 13/4.3@9x	10.7-3.6	3.5	1/4	1"	Black Matte	11.46	12
AC10037	4x	32	30/30 Red IR	25/8.3@4x	8	3.35	1/4	1"	Black Matte	16.08	11.93
AC13490	4x	32	30/30	23.58/7.87@4x	8	3.39	1/4	1"	Black Matte	8.29	8
AC10038	4x	32	30/30	29/9.6@4x	8	3	1/4	1"	Black Matte	16.08	11.93
AC10040	4x	32	30/30	29/9.6@4x	8	3	1/4	1"	Silver	16.08	11.93
AC10002	3-7x	20	30/30	21/7@3x, 10/3.3@7x	6.7-2.9	2.55	1/4	3/4"	Black Matte	4.87	10.5
AC10730	4x	20	30/30	18.3/5.5@4x	5.0	2.5	1/4	3/4"	Black Matte	4.8	10.55
AC10000	4x	15	30/30	21/7@4x	3.75	2.75	1/4	3/4"	Black Matte	3.63	10.63



AR-X PRO

PRISM SCOPE



3x30
AC12692

The AR-X PRO is an innovative prism scope system that was designed for law enforcement and tactical applications. AR-X PRO scope feature a newly designed Cross-Dot Illuminated Reticle, which can be switched between red, green, or blue. The brightness of the illuminated reticle can also be adjusted to better match the current lighting environment. The AR-X PRO is equipped with a tough rubber armor, which protects the scope from external damage and impact. The AR-X PRO also features external adjustable windage/elevation turrets, which makes it easy for the user to make quick corrections to their scopes settings.

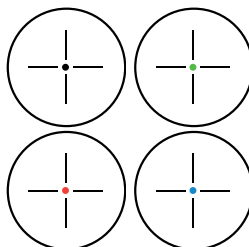

Cross Dot Reticle: Features a center lit green, red or blue illuminated reticle.

AR-X Pro Scope Features

Waterproof and fogproof | Glare reducing rubber body | Extra rigid shockproof construction | Multi-Coated optics | Illuminated red, green and blue reticles | External easy-grip windage and elevation adjustments | Precise and easy-to-use for tactical environments | 1/4" MOA adjustments | Integrated weaver style/picatinny base | IR green, red or blue center lit cross dot reticle | One Year Limited Warranty

Model #	Magnification	Objective Lens (mm)	Reticle	Field of View (ft@100yds/m@100m)	Exit Pupil (mm)	Eye Relief (inch)	Click Value	Tube Diameter	Finish	Weight (oz.)	Length (inch)
AC12692	3x	30	Cross Dot	36.75/12.25	9	2.75	1/4	N/A	Matte Black	16	4.75



3x30 IR AR-X
AC12146

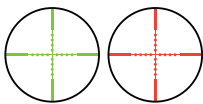

Illuminated green or red mil-dot IR reticle pattern | 5 levels of brightness | Protective rubber armor | Retaining cable for windage and elevation caps | Built-in sniper edged sun-shade | Standard picatinny rail mount | Includes battery and flip-up scope caps



1x35 IR AR-X
AC12176

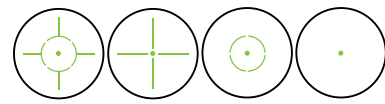

4 different illuminated green or red reticle patterns | 5 levels of brightness | Windage and elevation adjustments | Built-in sniper edged sun-shade | Standard picatinny rail mount | Includes battery and flip-up scope caps

Model #	Magnification	Objective Lens (mm)	Reticle	Field of View (ft@100yds/m@100m)	Exit Pupil (mm)	Eye Relief (inch)	Click Value	Tube Diameter	Finish	Weight (oz.)	Length (inch)
AC12146	3x	30	Dual Color Mil-Dot IR	39.37/13.12	10	2.75	1/4	30mm	Black Matte	16	5.5
AC12176	1x	35	Dual Color Multi-Reticle IR	59.05/19.68	35	3.7	1	30mm	Black Matte	13.6	5.25

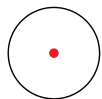

1x20 HQ Red Dot
AC13158

Compact in size | Push button illuminated red dot reticle | Adjustable sensed brightness setting | Windage and elevation adjustments | Standard weaver style rail mount | Includes batteries and scope caps



1x30 HQ Red Dot
AC13160

Push button illuminated red dot reticle | Adjustable sensed brightness setting | Windage and elevation adjustments | Standard weaver style rail mount | Includes batteries and flip-up scope caps

Model #	Magnification	Objective Lens (mm)	Reticle	Field of View (ft@100yds/m@100m)	Exit Pupil (mm)	Eye Relief (inch)	Click Value	Tube Diameter	Finish	Weight (oz.)	Length (inch)
AC13158	1x	20	Red Dot IR	36/12	18	Unlimited	1/1	na	Black Matte	7	2.95
AC13160	1x	30	Red Dot IR	57/19	26	Unlimited	1/1	na	Black Matte	10.8	4.13

ELECTRO SIGHT | Tactical Scope Series

4x20 Electro Sight Carry handle scope is specifically designed for M-16 & AR-15 Rifles. Features a built-in bullet drop compensation system calibrated to 500 yards in 100 yards increments. Integrated base that easily mounts on to the inside track of a rifles carry handle, at base of the integrated mount is a peep sight that allows you to use the rifles iron sight. Improved design and fully coated crisp clear optics.



4x20 M16
Carry Handle Scope
AC10838



4x20 M16
Carry Handle Scope
AC11608

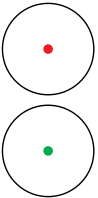

1x30 Electro Sight
AC13084

Mounts on the carry handle or on picatinny / weaver style bases. Quick targeting acquisition. Features an adjustable reticle brightness for the illuminated red or green red dot to fit any lighting situation. Waterproof, fogproof, and shockproof. Includes battery.



4x32 M16 Sight
AC12268



4x magnification for quick target acquisition, and the adjustable reticle brightness to fit any lighting situation. Perfect fit for AR-15 style rifles. Waterproof, fogproof, and shockproof, and can withstand repeated recoil without losing zero. Includes battery and standard weaver style base.

Model #	Magnification	Objective Lens (mm)	Reticle	Field of View (ft@100yds/m@100m)	Exit Pupil (mm)	Eye Relief (inch)	Click Value	Finish	Weight (oz.)	Length (inch)
AC13084	1x	30	Red / Green Dot	54/18	23	Unlimited	1/4	Black Matte	10.56	5.3
AC10838	4x	20	30/30	22/7.3	5	2.7	1/2	Black Matte	13.4	6.9
AC11608	4x	20	Mil Dot	22/7.3	5	2.7	1/2	Black Matte	13.4	6.9

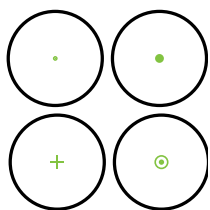

Multi-Reticle, Green/Red
AC11704

Multi-Reticle, Green/Red, Clam
AC11705

A multi-reticle panoramic sight, built with a standard 5/8" mount that is ideal for handgun, shotgun, crossbow, M-16 and more. Features 4 different reticle patterns, a 3-position rheostat illumination and powered by a lithium battery. With a screen size of 22mmx33mm, this sight provides unlimited eye relief and unlimited field-of-view.

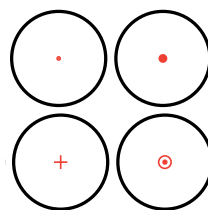

Multi-Reticle, Red
AC10632

A multi-reticle panoramic sight, built with a standard 5/8" mount that is ideal for handgun, shotgun, crossbow, M-16 and more. Features 4 different reticle patterns, a 3-position rheostat illumination and powered by a lithium battery. With a screen size of 22mmx33mm, this sight provides unlimited eye relief and unlimited field-of-view.

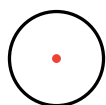

1x30 ION Reflex Sight
AC13152

Panoramic sight with integrated standard quick release 5/8" mount ideal for handgun, shotgun, crossbow, M-16 and more. Features illuminated red dot reticle with an adjustable rheostat.

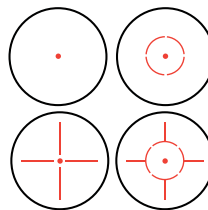

1x40 ION Reflex Sight
AC13154

A multi-reticle panoramic sight with a quick release built in standard 5/8" mount ideal for handgun, shotgun, crossbow, M-16 and more. Features 4 different red reticle patterns and an adjustable rheostat.

Model #	Magnification	Objective Lens (mm)	Reticle	Field of View (ft@100yds/m@100m)	Exit Pupil (mm)	Eye Relief (inch)	Click Value	Finish	Weight (oz.)	Length (inch)
AC11704	1x	22-33	Green and Red Multi Reticle	51.84/15.8	n/a	Unlimited	1/2	Black Matte	4.06	3.12
AC10632	1x	22-33	Red Multi Reticle	51.84/ 15.8	n/a	Unlimited	1/2	Black Matte	4.06	3.12
AC13152	1x	30	Red Dot	Unlimited	n/a	Unlimited	1 MOA	Black Matte	3.9	2.37
AC13154	1x	40	Red Multi Reticle	Unlimited	n/a	Unlimited	1 MOA	Black Matte	6.2	3.6



1x30, 4" Red Dot
AC12142

- 1x magnification
- 4 MOA red reticle
- Standard weaver style/picatinny base



The Barska 30mm 4" scope is an advanced red dot scope with adjustable brightness for almost any shooting situation. Ideal for CQB situations, and allows for quick target acquisition. Includes cantilever picatinny scope mount, low picatinny scope mount and flip-up lens covers.

1x30, 7" Red Dot
AC12144

- 1x magnification
- 4 MOA red reticle
- Standard weaver style/picatinny base



The Barska 30mm 7" scope is an advanced red dot scope with adjustable brightness for almost any shooting situation. Ideal for CQB situations, and allows for quick target acquisition. Includes a picatinny-style mount and flip-up lens covers.

Model #	Magnification	Objective Lens (mm)	Reticle	Field of View (ft@100yds/m@100m)	Exit Pupil	Eye Relief (inch)	Click Value	Tube Diameter	Finish	Weight (oz.)	Length (inch)
AC12142	1x	30	4 MOA, DC	70/23.33	30mm	Unlimited	1/2"	30mm	Black Matte	8	4.15
AC12144	1x	30	4 MOA, DC	60/20	30mm	Unlimited	1/2"	30mm	Black Matte	12	7



Ultra-fast target acquisition, pinpoint accuracy and wide field of view make the red dot series ideal for handguns, rimfire rifles, pistols and crossbows. Each Red Dot has a finger adjustable rheostat for variable reticle brightness control, anti-reflective coating, and integrated mount for optimum performance. Selected models feature a state-of-the-art dual-color green & red dot reticle for all-day shooting versatility. All red dots feature wide field of view, unlimited eye relief and multi-coated optics.

30mm Silver
AC11086



- Red 5 MOA reticle
- Standard weaver style base



30mm
AC11088,
AC11089 Clam



- 3-dot red reticle
- Standard weaver style base
- For crossbow or compound bow



50mm
AC10332



- Red 5 MOA reticle
- Standard weaver style base



30mm, Clam
AC10329



- 30mm**
AC10328
- Red 5 MOA reticle
 - Standard weaver style base



2x30mm
AC11090



- 2x magnification
- 5 MOA red reticle
- Standard weaver style base



Model #	Magnification	Objective Lens (mm)	Reticle	Field of View (ft@100yds/m@100m)	Exit Pupil	Eye Relief (inch)	Click Value	Tube Diameter	Finish	Weight (oz.)	Length (inch)
AC11086	1x	28	5 MOA	68/24.7	28mm	Unlimited	1/4	30mm	Silver	7.2	3.75
AC11088	1x	28	3.5 MOA	68/24.7	30mm	Unlimited	1/4	30mm	Black Matte	4.8	3.75
AC10328	1x	30	5 MOA	57/19	30mm	Unlimited	1/2	38mm	Black Matte	4.8	3.75
AC10332	1x	50	5 MOA	80/27	50mm	Unlimited	1/2	52mm	Black Matte	7	4.0
AC11090	2x	30	5 MOA	68/24.7	15mm	Unlimited	1/4	30mm	Black Matte	8.8	5.25



GLX ^{3rd GEN}

GREEN LASER RIFLE SIGHT

GLX Green Tactical Laser Sight AU11404

BARSKA's GLX third generation tactical laser sight features external riflescope style windage and elevation (W/E) adjustments for quick, high precision targeting. The tactical design integrates a tactical edged bezel into the strong T6 aluminum body for added protection. The diamond cut exterior grip improves the mounting capability of the picatinny 1" mounting ring included with the laser sight.

Features

- Working temperature between 59°-95°F
- External riflescope style windage and elevation adjustments
- Tactical edged bezel
- Diamond cut exterior grip
- 1" inch main tube

Includes

- 1" picatinny rail ring with removable cross-bar
- Continuous push button on/off cap
- Momentary on/off long cable switch
- 1 CR-123A lithium battery



Item #	Description	Mount	Output Power	Wavelength	Max Reach Capacity	Adjustment Type	Battery Type	# Battery Included
AU11404	GLX Green Tactical Laser Sight	Picatinny/Weaver Style Ring	<5mW	532(±10)nm	1000 YDS	Windage/Elevation	CR-123A	1



GREEN LASER 200 LUMEN FLASHLIGHT

AU12716

The green laser flashlight combo by Barska features a 200 lumen intense bright light and 5mW high power green laser sight integrated into one compact unit with a built-in weaver style /picatinny mount. Multiple function modes allow you to use just the flashlight, just the laser or both at the same time. The green laser features windage and elevation adjustments for precision targeting.

- New mount, easily attaches / detaches from standard size handgun/rifle/pistol with weaver style/picatinny rails
- Three different target acquisition methods: flashlight, laser, and flashlight and laser together
- Working temperature between 59°-95°F
- Includes two CR123A batteries and momentary on/off long cable switch



RED LASER 200 LUMEN FLASHLIGHT

AU12714

The 5mW red laser flashlight combo by Barska features a 200 lumen intense bright light and 5mW high power red laser sight integrated into one compact unit with a built-in weaver style/picatinny mount.

- New mount, easily attaches / detaches from standard size handgun/rifle/pistol with weaver style/picatinny rails
- Three different target acquisition methods: flashlight, laser, and flashlight and laser together
- Working temperature between 14°F - 104°F
- Includes two CR123A batteries and momentary on/off long cable switch

Patent Pending

Item #	Description	Mount	Output Power	Wavelength	Max Reach Capacity	Adjustment Type	Battery Type	# Battery Included
AU12716	Green Laser with 200 Lumen Flashlight, 2nd Gen	Picatinny/Weaver Style	<5mW	532(±10)nm	1000 YDS.	Windage/Elevation	CR-123A	2
AU12714	Red Laser with 200 Lumen Flashlight, 2nd Gen	Picatinny/Weaver Style	<5mW	650(±10)nm	500 YDS.	Windage/Elevation	CR-123A	2

MULTI-RAIL GLX LASER SIGHT

GLX Green Laser Sight AU11408 **GLX Red Laser Sight** AU11406

BARSKA's GLX compact mounted laser sights are designed with an accessory rail mounted conveniently under the laser. The T6 aluminum body allows for the GLX laser sight to provide a strong, stable platform to mount accessories to its integrated standard picatinny rail. Securely mounts to the shortest of rails on handguns bottom rails and rifles picatinny rail forends. Built-in weaver style/picatinny standard mount with a cross-bar insert.

Working Temperature Between

- Green - 59°-95°F
- Red - 14°-104°F

Includes

- Momentary on/off long cable switch
- 1 CR-123A lithium battery



RED LASER FLASHLIGHT WITH SCOPE MOUNT

AU11005

- Precision of a laser sight with the illumination of a high intensity flashlight
- Working temperature between 14°-104°F
- Laser tube diameter 19mm
- Laser features windage and elevation adjustments
- Mount for 1" riflescope tube
- Includes riser bar and batteries



RED LASER PICATINNY / WEAVER STYLE RAIL

AU11069

- Ideal for pistols and rifles
- Working temperature between 41°-95°F
- Tactical weaver style detachable mount with removable locking cross-bar
- Laser tube diameter 15mm
- Windage and elevation adjustments
- Includes tools and batteries



RED LASER INTEGRATED FRONT SIGHT

AW11880

- Detachable front sight with integrated red laser sight
- Working temperature between 60°-95°F
- Windage and elevation adjustments
- Attaches/detaches to picatinny/weaver style rails
- Includes pressure switch and batteries

Item #	Description	Mount	Output Power	Wavelength	Max Reach Capacity	Adjustment Type	Battery Type	# Battery Included
AU11408	GLX Green Laser Sight	Picatinny/Weaver Style	<5mW	532(±10)nm	1000 YDS	Windage/Elevation	CR-123A	1
AU11406	GLX Red Laser Sight	Picatinny/Weaver Style	<5mW	650(±10)nm	1000 YDS	Windage/Elevation	CR-123A	1
AU11005	Tactical Red Laser Sight with Flashlight and Mount	Mount for 1" Riflescope Tube	<5mW	650(±10)nm	500 YDS.	Windage/Elevation	CR-123A and LR-44 Lithium	4
AU11069	Red Laser Pistol/Rifle Sight with Picatinny Compact Weaver Style Rail	Picatinny/Weaver Style	<5mW	650(±10)nm	500 YDS.	Windage/Elevation	LR-44 Lithium	3
AW11880	Front Sight with Integrated Red Laser Sight	Picatinny/Weaver Style	2.5-3.1mW	640(±10)nm	300 YDS.	Windage/Elevation	LR-44 Lithium	3



210 LUM, LED FLX Flashlight
BA11497



3 Levels of brightness | Strobe effect | S.O.S. light pattern | Water resistant | Includes momentary on/off long cable switch, 1" low weaver style mounting ring and wrist strap

25 LUM, LED Headlamp Flashlight
BA11579



Hands free high intensity flashlight | 12 bright white LED lights | Water resistant and shockproof | Lights up to 98ft/30m | Lightweight and comfortable | Tilting head, hinged attachment to position beam | Adjustable head strap, one size fits all

Item	Lumens	Lamp Type	Battery Life Continuous Use	Battery	Tube Diameter	Length (Inch)	Weight (oz.)
BA11497	210	LED	2.2 Hrs	2 CR123	1 Inch	6.75	3.52
BA11579	25	LED	36 Hrs	3 AAA	n/a	2.00	2.82

TACTICAL COMBINATIONS

A variety of BARSKA tactical electro sights combined with precision accessories to suit your shooting needs. Electro sights feature external Picatinny multi-rails that allow you to customize your scope with additional aiming accessories. Combos may include; Tactical flashlight, Green or Red GLX laser sight and/or red dot.



Green 5mW Tactical Laser Sight
AU11404

External riflescope style windage and elevation | Includes 1" picatinny rail ring with removable cross-bar and momentary on/off long cable switch



Green 5mW Laser Sight
AU11408

Red 5mW Laser Sight
AU11406

Built-in weaver style standard compact mount with a stabilizing cross bar insert | Ideal on rifles picatinny rail forends as it is on a handguns' bottom rail | Includes momentary on/off long cable switch and battery



Red Laser and Flashlight
AU11005

Precision of a 5mw red laser with the illumination of a 35 lumen flashlight | Only 3 3/4" in length and weighs 5.6 oz. | Includes mount and riser bar



210 LUM, LED Flashlight
BA11497

3 Levels of brightness | Strobe effect | S.O.S. light pattern | Includes momentary on/off long cable switch, 1" low weaver style mounting ring and wrist strap

SHOOTING ACCESSORIES

Our lineup of shooting accessories includes a wide selection of shooting and precision aid accessories including a 15 piece boresighter kit, mounts, bipods and a variety of parts and tools that are just as reliable as the BARSKA products they're intended to pair.

BORESIGHTER KIT

BARSKA's 15 Piece Boresighter Kit will ensure that your rifle is accurately zeroed when you're testing out a new rifle and scope combination. This Boresighter fits snugly in the rifle barrel to eliminate any "play" that can result in an inaccurate boresighting adjustment and poor shooting accuracy

Caliber

Caliber (Cal.) is a system of measurement for the internal bore diameter of a rifled-barreled firearm (rifle or pistol) based on the decimal part of an inch (.22 Cal) or in millimeters (9mm). American caliber designations refer to the distance from land to land, not groove to groove.

UNIVERSAL PARTS & TOOLS

Our selection of high quality tactical parts and tools includes some of the most popular and essential types at extremely affordable prices. These products are made of high-strength carbon steel and are designed for years of use.

RINGS

BARSKA scope rings are precision engineered and manufactured using T6 Aluminum and Aluminum alloy for durability and weight savings. Selecting rings with the correct height to use with your scope depends on several factors including barrel taper, action length, ring position on the scope and the outside objective diameter of the scope. To help you determine which BARSKA ring model to select, refer to the chart in this section.

H-Height

Describes how high the rings lift the riflescope off the rifle body.

Height	Inches
Low	0.7" - 0.9"
Medium	0.9" - 1.2"
High	1.2" - 1.4"
Extra High	1.4" and above

D-Diameter

Refers to the inner diameter of the ring.

O-Overall

The height of the entire ring, from top to bottom.

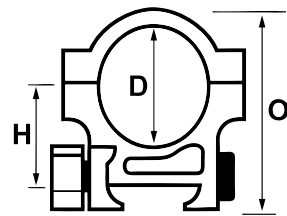

MOUNTS

BARSKA bases are designed to provide you with solid performance in the field. T6 Aluminum construction results in durability and lighter weight while the rugged cross slot bolts secure the bracket to provide extreme rigidity. These bases permit the mounting of a variety of firearms.

Types Of Mounts

Picatinny

A term for a mounting rail system where grooves are .206" wide and have a consistent center-to-center width of .394".

Weaver Style

A term for a mounting rail system where grooves are .180" wide and most have a consistent center-to-center width of .180. Most Weaver-style accessories will fit the Picatinny system however Picatinny accessories will not fit the Weaver-style system.

Dovetail

Airgun dovetail is a parallel set of grooves running along the top of a receiver to which bases may be clamped. The width of the airgun dovetail is 11mm, but can range from 9.5mm to 14mm.

BIPODS

To make consistently accurate shots critical last-second adjustments to the rifle's position is usually always required along with a stable rest. With this in mind, we created our newest line of bipod models with features that allow you to easily set up and make these necessary adjustments. These bipods fit AR-15 and SKS rifles and also include a universal model that will fit an almost unlimited choice of rifle types.

Minimum Height

Refers to the length of the legs when they are it's shortest.

Maximum Height

Refers to the length of legs when fully extended.

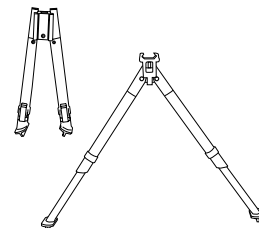

WARRANTY

Shooting accessories come with a 60-Day or 1-Year Limited Warranty USA and Canada Only, This warranty does not cover consumer caused damages, abuse, normal wear-and-tear, unauthorized repairs or modifications. For more information, please refer to warranty policy enclosed with products.

1-Year Warranty	
Bipods	Boresighter Kit
Cleaning Kits	Mounting Rings
Riflescope Mounts	AR Quad Rails
60-Day Limited Warranty	
Parts & Tools	

FLASHLIGHTS

Flashlights help to maintain a clear view in the dark or low light situations. Flashlights are available in a wide variety of sizes, powers and features depending on usage and intended purpose.

Lumen

The total amount of illumination a flashlight gives off is measured in lumens. A lumen is the amount of light emitted by one birthday candle located one foot away from the viewer.

Flashlight Warranty

Flashlights come with a 1-Year Limited Warranty USA and Canada Only, This warranty does not cover consumer caused damages, abuse, normal wear-and-tear, unauthorized repairs or modifications. For more information, please refer to warranty policy enclosed with products.

LASERS

Laser sights are one of the most accurate tools for pinpointing a target. The laser will project a small illuminated dot that will represent the anticipated point of impact. This ensures accuracy when it has been mounted and then calibrated to the weapon through target practice prior to use in a real situation.

Green Vs. Red

Green is closer to the center of the visible spectrum, at 532 nanometers, so it's easier for our eyes to perceive the color vs. a red laser at 635 nanometers. A green laser can appear as much as 50 times brighter than the red equivalent. 532nm is the ideal wavelength to maximize visibility during day or night, which makes green lasers much more visible than red lasers.

Windage and Elevation

The windage and elevation adjustments affect accuracy and are used adjust the beam of the laser. Windage is the horizontal (left-to-right) adjustment. Elevation is the vertical (up-and-down) adjustment

Laser Warranty

Lasers come with a 1-Year Limited Warranty USA and Canada Only, This warranty does not cover consumer caused damages, abuse, normal wear-and-tear, unauthorized repairs or modifications. For more information, please refer to warranty policy enclosed with products.



Tactical Vertical Handle Grip

AW11173

- Have greater stability and control for easier aiming, especially during rapid fire
- Includes mounting rail and allen wrench
- Fits weaver style picatinny forend rails

Item#	Description	Length (in)	Width (in)	Material	Color/Finish
AW11173	Tactical Vertical Handle Grip	4.56"	1.87"	High Impact Polymeric Vertical Forend Grip/Steel Shaft	Black/Matte



15 Piece Iron Boresighter Kit

AW11076

This Boresighter Kit will ensure that your rifle is accurately zeroed when you're testing out a new rifle and scope combination. This system uses a 15 piece arbor set that ranges from .177 to .50 caliber and ensures precise bullet placement from the get go. This boresighter fits snugly in the rifle barrel to eliminate any "play" that can result in an inaccurate boresighting adjustment and poor shooting accuracy. To use the boresighter reticle adjust windage and elevation turrets until the cross hairs line up with the center of the boresighter's grid. Includes hard carrying case.

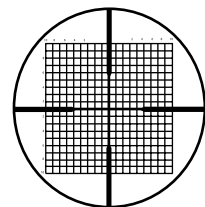
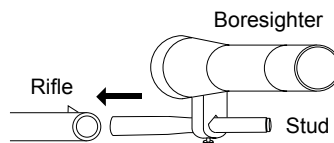

Boresighter's Reticle

How a Boresighter Works
 Insert stud into boresighter and insert other end into barrel. Align internal grid. Scope is now pre-zeroed.

1-Year Limited Warranty

Item #	Description	Type	Arbor Studs Caliber (Min.-Max)							
AW11076	15- Iron Boresighter Kit	Iron	0.177	0.22	6mm	.25	6.5mm	.27	7mm	0.30
			.32	.338	.35	.375	.44	.45	.50	



Bipods

To make consistently accurate shots critical last-second adjustments to the rifle's position is usually always required along with a stable rest. Our bipods allow you to easily set up and make these necessary adjustments. Easy to use and install, legs fold up for easy storage. Made from strong and lightweight aluminum construction.

AR-15 Handguard Rail Bipod
AW11078



Spring Loaded Adjustable Bipod
AW11896



Spring Loaded Adjustable Bipod, Low
AW11894

Picatinny/Weaver Style Bipod
AW11886



Picatinny/Weaver Style Bipod, High
AW11888

Picatinny/Weaver Style Bipod

The adjustable bipod legs feature a posi-lock wheel and rubberized feet to prevent slipping.

Barrel Clamp Bipod
AW11890



Spring Loaded Bipod

A quick deploying bipod, the legs are spring loaded for tension control so they can be retracted quickly. The adjustable bipod legs feature a posi-lock wheel and rubberized feet to prevent slipping. Includes a swivel stud and picatinny mount adaptor.

Barrel Clamp Bipod

Clamps on to rifle's barrel for a more stable platform. Wheel adjustment that clamps on a range of barrel sizes from 11mm to 19 mm. The adjustable bipod legs feature a posi-lock wheel and rubberized feet to prevent slipping.

1-Year Limited Warranty

Item #	Description	Adjustable Height Min-Max Inches	Material	Color / Finish	Rail Type
AW11078	AR-15 Handguard Rail Bipod	8.3"-11.4"	Aluminium	Black/Matte	Picatinny/Weaver style forends rails
AW11896	Spring Loaded Adjustable Bipod, Standard	8"-12"	Aluminium	Black/Matte	Picatinny/Weaver style forends rails
AW11894	Spring Loaded Adjustable Bipod, Low	5.5"-7"	Aluminium	Black/Matte	Picatinny/Weaver style forends rails
AW11886	Picatinny/Weaver Style Bipod, Medium Height	6.5"-8"	Aluminium	Black/Matte	Picatinny/Weaver style forends rails
AW11888	Picatinny/Weaver Style Bipod, High Height	8"-10"	Aluminium	Black/Matte	Picatinny/Weaver style forends rails
AW11890	Barrel Clamp Bipod, Medium Height	6.7"-7.5"	Aluminium	Black/Matte	Range of barrel sizes between 11mm to 19

BARSKA scope rings are precision engineered and manufactured using T6 Aluminum and Aluminum alloy for durability and weight savings. Selecting rings with the correct height to use with your scope depends on several factors including barrel taper, action length, ring position on the scope and the outside objective diameter of the scope. To help you determine which ring model to select, refer to the chart on this page.

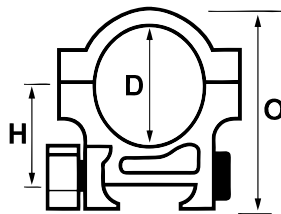

Height	Inches
Low	0.7" - 0.9"
Medium	0.9" - 1.2"
High	1.2" - 1.4"
Extra High	1.4" and above

1" Medium Weaver Style Ring, Silver
AI13298



1" Medium Dovetail/Airgun/.22 Style Ring, Silver
AI13300



1" Medium Weaver Style HQ Ring
AI13184



1" High Weaver Style HQ Ring
AI13186



30mm Medium Weaver Style HQ Ring
AI13188



30mm High Weaver Style HQ Ring
AI13190



1" Ring w/ Picatinny Top Rail
AI13210



1" Medium Weaver Style Ring
AI12664



1" High Quick Release Weaver Style Ring
AI12244



30mm X-High Picatinny Style Ring
AI11766



Mounting rings have a 1-Year Limited Warranty

Model #	Description	H-Height	D-Diameter	O-Overall	Material	#Rings/Pkg	#Set Screw	#Lock Nuts
AI13298	1" Medium Weaver Style Ring, Silver	1.08"	1"	1.67"	Aluminum	2	1	2
AI13300	1" Medium Dovetail/Airgun/.22 Style Ring, Silver	1.13"	1"	1.67"	Aluminum	2	1	2
AI13184	1" Medium Weaver Style HQ Ring	1.05"	1"	1.84"	Aluminum	2	1	4
AI13186	1" High Weaver Style HQ Ring	1.1"	1"	2.03"	Aluminum	2	1	4
AI13188	30mm Medium Weaver Style HQ Ring	1.2"	30mm	1.97"	Aluminum	2	1	4
AI13190	30mm High Weaver Style HQ Ring	1.35"	30mm	2.28"	Aluminum	2	1	4
AI13210	1" Ring w/ Picatinny Top Rail	.98"	1"	1.57"	Aluminum	1	0	4
AI12664	1" Medium Weaver Style Ring	1.08"	1"	1.67"	Aluminum	2	1	2
AI12244	1" High Quick release Weaver Style Ring	1.2"	1"	1.95"	Aluminum	2	1	4
AI11766	30mm X-High Picatinny Style Ring	1.54"	30mm	2.36"	Aluminum	2	1	2



30mm X- High Peep Sight Weaver Style Ring w/ 1" Insert and Picatinny Top Rail
AI11480



Includes 1 detachable rail top,
1 standard top and 1" inserts

30mm High Peep Sight Weaver Style Ring w/ 1" Insert and Picatinny Top Rail
AI11484



Includes 1 detachable rail top,
1 standard top and 1" inserts

30mm Low Weaver Style Ring w/ 1" Insert and Picatinny Top Rail
AI11490



Includes 1 detachable rail top,
1 standard top and 1" inserts

Barrel Ring Mount
AI11742



30mm Picatinny Style Offset Ring w/ 1" Insert
AI11720



Shotgun Ring Mount
AI11726



30mm High Dovetail Style Ring
AI11756



1" Medium Dovetail / Airgun / .22 Style Ring
AI10342



1" High w/Peep Sight Dovetail / Airgun / .22 Style Ring
AI10344



Model #	Description	H-Height	D-Diameter	O-Overall	Material	#Rings/Pkg	#Set Screw	#Lock Nuts
AI11480	30mm X- High Peep Sight Weaver Style Ring w/ 1" Insert and Picatinny Top Rail	1.57"	30mm	2.48"	Aluminum	2	1	6
AI11484	30mm High Peep Sight Weaver Style Ring w/ 1" Insert and Picatinny Top Rail	1.22"	30mm	2.12"	Aluminum	2	1	6
AI11490	30mm Low Weaver Style Ring w/ 1" Insert and Picatinny Top Rail	.94"	30mm	1.73"	Aluminum	2	1	6
AI11742	Barrel Ring Mount	.94"	30mm	1.73"	Aluminum	1	1	2
AI11720	30mm Picatinny Style Offset Ring w/ 1" Insert	.88"	30mm	1.75"	Aluminum Alloy	1	1	4
AI11726	Shotgun Ring Mount	1.45"	1"	2.38"	Aluminum Alloy	1	1	4
AI11756	30mm High Dovetail Style Ring	1.41"	30mm	2.08"	Aluminum	2	1	2
AI10342	1" Medium Dovetail / Airgun / .22 Style Ring	1.13"	1"	1.63"	Aluminum	2	1	2
AI10344	1" High w/Peep Sight Dovetail / Airgun / .22 Style Ring	1.5"	1"	1.99"	Aluminum	2	1	2



30mm Medium Ruger Style Ring w/ 1" Insert
AI11059



30mm X-High HD Weaver Style Ring w/ 1" Insert
AI11063



30mm Low Weaver Style Ring
AI10338



30mm Medium Weaver Style Ring
AI10340



30mm High Weaver Style Ring
AI10826



1" Low Weaver Style Ring
AI10334



1" Low w/Peep Sight Weaver Style Ring
AI10336



1" High w/Peep Sight Weaver Style Ring
AI10468



Model #	Description	H-Height	D-Diameter	O-Overall	Material	#Rings/Pkg	#Set Screw	#Lock Nuts
AI11059	30mm Medium Ruger Style Ring w/ 1" Insert	1.19"	30mm	1.88"	Aluminum Alloy	1	1	4
AI11063	30mm X-High HD Weaver Style Ring w/ 1" Insert	1.45"	30mm	2.38"	Aluminum Alloy	2	1	4
AI10338	30mm Low Weaver Style Ring	.81"	30mm	1.69"	Aluminum	2	1	2
AI10340	30mm Medium Weaver Style Ring	.98"	30mm	1.87"	Aluminum	2	1	2
AI10826	30mm High Weaver Style Ring	1.25"	30mm	2.02"	Aluminum	2	1	2
AI10334	1" Low Weaver Style Ring	.69"	1"	1.44"	Aluminum	2	1	2
AI10336	1" Low w/Peep Sight Weaver Style Ring	.87"	1"	1.62"	Aluminum	2	1	2
AI10468	1" High w/Peep Sight Weaver Style Ring	1.18"	1"	2.00"	Aluminum	2	1	2

CANTILEVER RING MOUNT | Shooting Accessories



35mm Dual Cantilever Mount
AW12742



One piece ring mount that allows for extra mounting room for almost any 35mm optic accessory. 6 heavy duty screws keep the optic in place.

Pair of Cantilever Mount with Integrated 30mm Ring, Picatinny Rail Top and 1" Inserts
AW11768



Pair of cantilever flat top AR rings with integrated 30mm ring and 1 detachable rail top and 1" inserts, This forward offset mounting ring allows mounting of longer riflescopes on your flat top AR. Includes picatinny rail top for mounting optional shooting accessory. 6 heavy duty screws keep the optic in place and a large thumb lock screw keep the mount securely on firearm.

Pair of Cantilever Mount with Integrated 30mm Ring and 1" Insert
AW11677



This forward offset mounting rings allows for extra mounting room for almost any 30mm or 1" optic accessory. 6 heavy duty screws keep the optic in place and a large thumb lock screw keep the mount securely on firearm.

Mounts have a 1-Year Limited Warranty.

Item #	Description	Rail Type	Rail Length	Material	Color/Finish	Applicable Firearm
AW12742	35mm Dual Cantilever Ring Mount	Picatinny/Weaver Style	5.5"	T6 Aluminum	Black/Matte	Various
AW11768	Pair of Cantilever Mount With Integrated 30mm Ring Picatinny Rail Top and 1" Inserts	Picatinny/Weaver Style	1.75" Each	T6 Aluminum	Black Matte	Various
AW11677	Pair of Cantilever Mount with Integrated 30mm ring and 1" Inserts	Picatinny/Weaver Style	1.75" Each	T6 Aluminum	Black Matte	Various

BARSKA bases are designed to provide you with solid performance in the field. T6 Aluminum construction results in durability and lighter weight while the rugged cross slot bolts secure the bracket to provide extreme rigidity. Select bases feature rails that allow the mounting of additional accessories such as a riflescope, laser and or flashlight. These bases permit the mounting of a variety of firearms.



3x30 Magnifier AW11622
5x30 Magnifier AW11654



Works in combination with red dot or electro sight to magnify image, resulting in increased accuracy. Can also be used as a hand held magnifier. Waterproof, fogproof and shockproof. Fully coated optics and includes picatinny/weaver style mounting ring.

5 Section Key Mod Picatinny Rail AW13216



Installs quickly to most standard key mod hand guard rails and features a picatinny mounting system. Allows you to mount an additional accessory.

Picatinny Dual Offset Rail AW11724



Allows you to mount optic accessory on either side of this offset rail.

AR Flat Top Extended Riser Mount AW11748



This mount raises mounting platform to .94" adding height to attach a scope or optic accessory.

Flip Up Front Sight AW11882



Quick detachable front sight with adjustable square post. Precise elevation adjustments. Flip-up posi-lock design to guarantee zero.

Set of Weaver Style to Dovetail Rails, Short AW11764



Converts weaver style/picatinny to a dovetail rail.

Mounts have a 1-Year Limited Warranty.

Item #	Description	Rail Type	Rail Length	Material	Color/Finish	Applicable Firearm
AW11654	5x30 Magnifier	Weaver Style/Picatinny	Magnifier is 5"	Aluminum	Black/Matte	Various
AW11622	3x30 Magnifier	Weaver Style/Picatinny	Magnifier is 5"	Aluminum	Black/Matte	Various
AW13216	5 Section Key Mod Picatinny Rail	Picatinny	2.20"	Aluminum	Black/Matte	AR
AW11724	Picatinny Dual Offset Rail	Weaver Style/Picatinny	1.85"	Aluminum	Black/Matte	Various
AW11748	AR Flat Top Extended Riser Mount	Weaver Style/Picatinny	2.55"	Aluminum	Black/Matte	AR-15, M-16
AW11882	Flip Up Front Sight	Weaver Style/Picatinny	.90"	Aluminum	Black/Matte	AR15 and M16 styles
AW11764	Set of Weaver Style to Dovetail Rails, Short	Weaver Style/Picatinny	1.18" Each	Aluminum	Black/Matte	Various



AR Standard Carry Handle
AW11746



This two-in-one detachable carry handle for AR type rifles. Fits on flat top guns and acts both as a carry handle and a rear sight system. Integrated adjustable rear sight with windage and elevation clicks.

AR Riser Mount
AW11143



This mount raises mounting platform to 1/2" adding height to attach a scope or optic accessory. Features peep sight design allows you to use rifle's iron sight.

Standard AR -15 & M-16 Carry Handle Mount
AW11141



Pair you firearms with additional accessories on to the carry handle with out obstructing the iron sight view.

M-4 Handguard Rail Mount Short
AW11137



Designed with swivel housing and its picatinny dimensions allow for a wide rang of accessory applications.

Mini-14 Mount
AW11133



Designed to fit most newer models and specific to Ruger model 181 and mini-14 gun. Mount can also be modified to fit Ruger Ranch and Mini-30 rifles.

Dovetail to Weaver Style Converter
AW11449



Converts dovetail rail to picatinny/weaver style rail. 1/2" high rise mount.

Mounts have a 1-Year Limited Warranty.

Item #	Description	Rail Type	Rail Length	Material	Color/Finish	Applicable Firearm
AW11746	AR Standard Carry Handle	Weaver Style/Picatinny	7.0"	Aluminum	Black/Matte	AR-15, M-16
AW11143	AR Riser Mount	Weaver Style/Picatinny	5.2"	T6 Aluminum	Black/Matte	AR-15, M-16
AW11141	Standard AR -15 and M-16 Carry Handle Mount	Weaver Style/Picatinny	6.0"	T6 Aluminum	Black/Matte	AR-15, M-16
AW11137	M-4 Handguard Rail Mount-Short	Weaver Style/Picatinny	5.9"	T6 Aluminum	Black/Matte	M-4, AR-15, M-16
AW11133	Mini-14 Mount	Weaver Style/Picatinny	5.44"	T6 Aluminum	Black/Matte	Ruger Mini-14
AW11449	Dovetail to Weaver Style Converter	Weaver Style/Picatinny	4.75"	T6 Aluminum	Black/Matte	Various



AK Side Mount
AW11716



Rail is 5.31" in length. Features a quick release detachable side mount.

SKS Mount with Integrated Rail
AW11744



Installs on the SKS rifle by replacing the rear receiver cover.

AK Tri Rail
AW11718



Integrated picatinny tri-rails that attached to the receivers cover. Top rail is 6.06" in length.

Shotgun Handguard W/Rails for Remington 870
AW11996



Lower accessory rail system for the Remington 870 Shotgun to attach accessories such as a bipod flashlight, foregrip or laser. Two additional side rails for attaching more accessories.

Shotgun Forearm W/Rails for Mossberg 500A Forearm
AW12000



Lower accessory forearm rail system for the Mossberg 500A to attach accessories such as a bipod, flashlight, foregrip or laser. Two additional side rails for attaching more accessories.

Mounts have a 1-Year Limited Warranty.

Item #	Description	Rail Type	Rail Length	Material	Color/Finish	Applicable Firearm
AW11716	AK Side Mount	Weaver Style/Picatinny	4.13"	Aluminum	Black/Matte	AK
AW11744	SKS Mount with Integrated Rail	Weaver Style	3.4"	Steel and Aluminum	Black/Matte	SKS Rifles
AW11718	AK Tri Rail	Weaver Style/Picatinny	6.29"	Aluminum	Black/Matte	AK
AW11996	Shotgun Handguard W/Rails for Remington 870	Weaver Style/Picatinny	7.5"	Aluminum	Black/Matte	Remington 870 Shotgun 12 Ga. and alike
AW12000	Shotgun Forearm W/Rails for Mossberg 500A Forearm	Weaver Style/Picatinny	9"	Aluminum	Black/Matte	Fits Mossberg 500C Shotgun 20 Ga. and alike



Barrel system will attach to most any rifle barrel. Picatinny/Weaver Style rail(s) to easily attach tactical items such as bipod, flashlight, foregrip, optic accessory or laser. A variety of models to choose from.

Barrel Mount Rail
AW11712



Single Rifle Barrel Mount, Single Rail, 2 Sections
AW12006



Single Shotgun Barrel Mount, Single Rail 3 Sections
AW12010



Double Rifle Barrel Mount, Tri-Rail 2 Sections
AW12002



Double Rifle Barrel Mount, Tri-Rail 5 Sections
AW12004



Double Shotgun Barrel Mount Tri-Rail, 3 Sections
AW12008



Double Shotgun Barrel Mount, Tri-Rail 5 Sections
AW12012



Mounts have a 1-Year Limited Warranty.

Item #	Description	Rail Type	Rail Length	Material	Color/Finish	Barrel Range Diameter Inches
AW11712	Barrel Mount Rail	Weaver Style/Picatinny	1.57"	Aluminum	Black/Matte	.75-.9
AW12006	Single Rifle barrel Mount, Single rail, 2 sections	Weaver Style/Picatinny	1.2"	Aluminum	Black/Matte	.51-.78
AW12010	Single Shotgun barrel Mount, Single Rail, 3 sections	Weaver Style/Picatinny	1.7"	Aluminum	Black/Matte	.75-1.1
AW12002	Double Rifle barrel Mount, Tri-Rail, 2 sections	Weaver Style/Picatinny	1.2"	Aluminum	Black/Matte	.51-.78
AW12004	Double Rifle barrel Mount, Tri-Rail, 5 sections	Weaver Style/Picatinny	2.4"	Aluminum	Black/Matte	.51-.78
AW12008	Double Shotgun barrel Mount, Tri-Rail, 3 sections	Weaver Style/Picatinny	2.4"	Aluminum	Black/Matte	.75-1.1
AW12012	Double Shotgun barrel Mount, Tri-Rail, 5 sections	Weaver Style/Picatinny	2.4"	Aluminum	Black/Matte	.75"-1.1"



Flip Up Iron Sight Set

AW13258

- Spring loaded deployment system that automatically flips the sight up at the push of a button



Offset Flip Up Iron Sight Set

AW13260

- Spring loaded deployment system that automatically flips the sight up at the push of a button



Mossberg 500 Pistol Grip

AW13208

- Ergonomic design
- Quick and easy installation



Remington 870 Pistol Grip

AW13206

- Ergonomic design
- Integrated three position shell carrier
- Quick and easy installation

Parts & Tools have a 60-Day Limited Warranty

Item#	Description	Length (in)	Width (in)	Material	Color/Finish
AW13258	Flip Up Iron Sight Set	1.5"	2"	Aluminum	Black/Matte
AW13260	Offset Flip Up Iron Sight Set	1.5"	2"	Aluminum	Black/Matte
AW13206	Remington 870 Pistol Grip	6.25"	3.5"	High Impact Polymer	Black/Matte
AW13208	Mossberg 500 Pistol Grip	6"	3.5"	High Impact Polymer	Black/Matte



Pair of 18650 3.7V Li-Ion Rechargeable Batteries

AF12460

Ideal for BARSKA flashlights, charger not included.



Pair of CR123A 3V Lithium Batteries

AF11574

Ideal for BARSKA laser sights and flashlights, not rechargeable.



AK/SKS Front Sight Adjustment Tool

AW11171

- Designed to adjust the front sight for elevation and windage
- Solves the problems associated with sighting in SKS rifles and carbines



AR-15 Stock Wrench Tool

AW11165

Removes old extension tube and installs a new style without damaging the rifle finish



AR-15/M4 Combo Wrench Tool

AW13635

- Installs and disassembles free float tube, barrel nut
- 1/2" drive for socket wrench, extension tube carbine stock
- Screw drive tip for buttstock and compensator



AR-15 Combo Wrench Tool-Short

AW11169

6 TOOLS IN ONE

- Aligns barrel nut to the gas tube
- Installs or removes free floating tubes
- 1/2" drive for socket/torque tension wrench
- Installs and removes barrel extension tube
- Compensator wrench
- Buttstock tube wrench

Pressure Switch for AU12148

AF12650



Pressure Switch for AU11404

AF12646



On/Off Cap for AU11404

AF12644



On/Off Cap for AU12148

AF12648



Parts & Tools have a 60-Day Limited Warranty, No Warranty on AF11574

Item#	Description	Length (in)	Width (in)	Material	Color/Finish
AW11171	AK/SKS Front Sight Adjustment Tool	2.62"	1.50"	Carbon Steel	Black/Matte
AW11165	AR-15 Stock Wrench Tool	5.5"	1.18"	Carbon Steel	Black/Matte
AW13635	AR-15 Combo Wrench Tool	12.2"	2.10"	Carbon Steel	Black/Matte
AW11169	AR-15 Combo Wrench Tool Short	12.37"	1.87"	Carbon Steel	Pewter/Gloss

AR QUAD RAILS | Shooting Accessories



Forend Quad Rails. Four picatinny-style rails for flashlights, lasers and/or other accessories. Designed to dissipate heat from rifle barrel. Compatible with AR-15, M16, M4 and other standard AR carbine platforms. Backed by a 1-Year Limited Warranty.

6.75" M Lok Hand Guard w/ Rail
AW13246



6.75" Key Mod AR Hand Guard w/ Rail
AW13220



AR Forend Rail 6.75" Length
AW11736

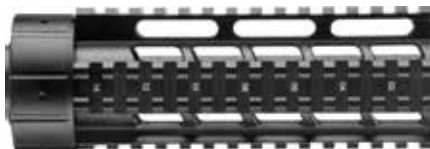

10" Key Mod AR Hand Guard w/ Rail
AW13244



AR Forend Rail 10" Length
AW11738

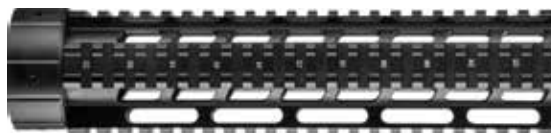

AR Forend Rail 12" Length
AW11772

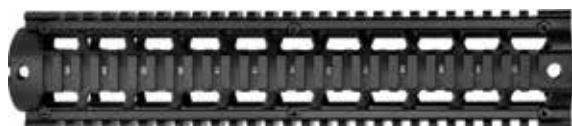

12" AR Quad Rail with Key Mod System
AW12688

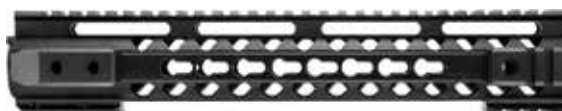

Sun Shade for Varmint Riflescopes

Sun shade to create custom length and to protect against glare. This shade keeps you shooting comfortably in even the brightest conditions. Rifle scope not included



5" Sun Shade for Varmint Scopes

50mm	42mm	40mm
AF11554	AF11548	AF11552

3" Sun Shade for Varmint Scopes

50mm	42mm	40mm
AF11778	AF11546	AF11550

Cleaning Kits

Rifle Cleaning Kit, w/Pouch

AW11966

12 Piece Kit

- 4 Bronze brushes
- 4 Rods
- 1 Dual-ended nylon brush
- 1 Slotted tip
- 1 1oz bottle
- Soft carrying pouch

2 Bronze Wire Brushes For	
.22 cal	30 cal



Shotgun Cleaning Kit, w/Flexible Rod and Pouch

AW11962

11 Piece Kit

- 2 Bronze brushers
- 2 Mops
- 1 Flex rod
- 1 T-handle
- 1 Threaded connector
- 1 Slotted tip
- 1 1oz bottle
- Cleaning patches
- Soft carrying pouch

2 Bronze Wire Brushes For	
12 gauge	20 gauge



Gun Cleaning Kit

AW11446

27 Piece Kit

- Solid brass rods for shotguns, rifles and pistols
- 10 Brass wire brushes
- 5 Mops
- 2 Brass accessory adaptors
- 2 slotted tips
- 1 Handle adaptor for .17 cal. rods
- 1 Universal handle
- Cloth patches
- Aluminum carrying case

10 Brass Wire Brushes for				
10/12 gauge	20/28 gauge	.410 gauge	.45 cal.	.40 cal.
.357/.38cal.,9mm	.30 cal.	.270/.280 cal.	.22 cal.	.17 cal.



Cleaning kits have a 1-Year Limited Warranty.

Item#	Description	Total Pieces	Case Dimensions L x W x H (inches)	Weight oz
AW11966	Rifle Cleaning Kit, w/Pouch	12	9.75 x .75 x 3.5	12
AW11962	Shotgun Cleaning Kit, w/Flexible Rod and Pouch	11	5.5 x 4.5 x 1.5	6
AW11446	Gun and Rifle Cleaning Kit	27	11.5 x 8 x 2	40.8



LOADED GEAR

www.LOADEDEGEAR.com

Loaded Gear™

Loaded Gear™ an innovative brand of products for today's active lifestyle. The AX series of cases are available in either aluminum framed or edge-to-edge hard case models in varying lengths. The HD series of cases are designed for professional equipment transport, these hard cases offer crush protection and include customizable pre-perforated cubed foam and layers of egg crate foam case liner to protect valuables from internal movement. The

RX series of bags are heavily padded for extra protection and feature additional pockets for accessories. These soft cases are easier to carry, tend to weight less and take up less space as compared to hard cases. Check out our tactical vests, tactical gear and backpacks found in this category. Select models are now available in different colors.

Firearm not included

Loaded Gear™ Hard Case Terminology

When purchasing a Loaded Gear™ hard case its best to familiarize yourself with the common features and specifications. Below are some of the most common Loaded Gear™ hard case terminology features explained. This information will help determine what each of the Loaded Gear™ tough cases feature and what the specifications mean. For more technical information all Loaded Gear™ hard storage utility cases have a set of features and a specification chart.

CASE MATERIAL

Hard cases are made from a polypropylene material resulting in a lightweight and durable case.

WATERTIGHT & AIRTIGHT PROTECTION

An o-ring is installed in all hard cases and is located in the groove of the lid of the case. As the lid and body of the tough case are locked together the o-ring becomes compressed between these two hard surfaces creating a seal resulting in a watertight and airtight seal.

REINFORCED BODY

Exterior edge-to-edge ribbing and reinforced corners distributes weight placed on the utility case that provides crush proof strength for securely storing your valuables and equipment.

PRESSURE RELIEF PURGE VALVE

The airtight feature of the hard cases makes the case difficult to open without first relieving the interior pressure or vacuum that is caused when encountering changes in atmospheric pressure. The purge valve allows air into the hard case making it easier to open the hard case when experiencing changes in altitude and or temperature. The purge valve is located near the handle of the dry case and turning the valve relieves the internal pressure in the hard case.

TEMPERATURE TOLERANCE

Utility cases can withstand freezing arctic cold and searing desert heat, between -10°F to 210°F

LOCKS & LATCHES

Most hard cases feature two built in padlock mounting holes so you can safely lock valuables in the hard case. Accepts most standard padlocks. Also features strong heavy duty latches that keep the case closed.

OUTER DIMENSIONS

Length - Describes length of the case

Width - Describes the width of the case

Depth - Describes the depth of the case

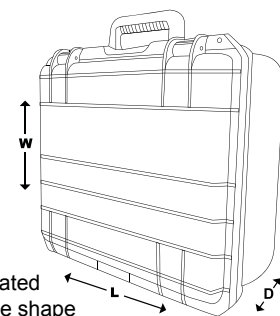

PRE-PERFORATED CUBED FOAM

Included with the hard cases are pre-perforated cubed foam that allows you to customize the shape of the foam.

How To Use the Cubed Foam

Consistently Shaped Item ex: laptop

1. Lay the item on top of the cubed sheet and trace the shape of the form that it occupies either with a felt tip marker or if don't any marks left over use a piece of chalk. Remember to leave room for accessories that will also be stored within the case.

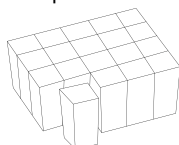

2. Carefully remove the pieces of foam that the shape occupies. Save these pieces just in case you ever need to modify the shape of the foam by gluing the pieces again. For a more custom fit, use scissors to cut the foam pieces.

Inconsistently Shaped Item ex: SLR camera

You may need to modify each pre-perforated cubed foam sheet

1. Use one sheet as the bottom shape that the object occupies and the other sheet as the top shape that the object occupies
2. Follow steps one and two of Consistently Shaped item

Notes on Placement :

The heavier or more sensitive the object is, the more foam you will want surrounding it for protection.

If possible place larger and heavier objects towards the hinges and smaller lightweight objects closer to the latches. Try to distribute the weight of the objects evenly to avoid making the case heavier at one end than the other. Try different configurations for best fit and protection.

LOADED GEAR™ HARD CASE WARRANTY

Backed by a One-Year limited warranty. The Loaded Gear™ Hard cases warranty does not include damage caused by excessive abuse, improper handling, installation, maintenance, unauthorized repairs or modifications and tampering in anyway. For more information, refer to enclosed warranty with products.

ABOUT LOADED GEAR™

Loaded Gear™ A Brand Of Innovative Active Products. At Loaded Gear™ our passion for innovation is our leading force to develop professional grade products and share them with today's active culture. Gear experts, we partner our brand with leading manufactures to drive innovation. Product designs powered by our industry expert's wealth of knowledge to bring concepts from design to market. To develop the best, we collaborate with professional equipment experts in the clothing, sporting goods, photography and consumer electronics industry.

Field-tested, Loaded Gear™ designs go through extensive real life application testing. Avid outdoor enthusiast make up our quality inspection engineer team. Loaded Gear produces professional gear with designs driven by technology and utility not by a market price point. Find professional Loaded Gear™ products at expert gear outfitters and major retail sporting good stores worldwide. We have the first-hand knowledge of how critical the quality of professional gear can be, that's why we stand behind our product with a Loaded Gear™ warranty and expert customer service. Visit www.loadedgear.com

HARD CASES

AX series of hard rifle cases are designed for secure storage and transport of weapons. These aluminum framed rigid rifle cases are designed with hard plastic molded crushproof end caps for added protection during transport. The AX series of hard cases all included customizable pre-perforated cubed foam and two layers of egg crate foam case liner to protect rifles from internal movement.



AX-200 50" Rifle Protective Hard Case w/ Wheels and Foam
BH11952

Features

- Two carrying handles
- Reinforced wheel rollers



AX-400 50" Double Sided Rifle Protective Hard Case w/ Foam
BH11982

Features

- Double sided storage case
- Center section safely separates two sides
- Carrying handle



AX-50 Protective Hard Case w/Foam
BH11948

Features

- Compact size allows for great protection on the go
- Resettable combination lock
- Securely store small valuable items such as phones, mp3 players etc.

Firearms not included

Model #	Description	Outer Dimensions LxWxD inches	Inner Dimensions w/o foam	Cubic Feet	Type of Lock	Weight lbs	Tie Down Holes	Material	Includes
BH11948	AX-50 Protective Hard Case w/Foam	11.25" x 10" x 3.5"	10" x 8.75" x 2.75"	0.14	Combination	2.8	n/a	Aluminum frame; ABS panel; molded polypropylene two-end cap	Top and bottom foam and pre-perforated cubed foam sheet
BH11952	AX-200 50" Rifle Protective Hard Case w/ Wheels and Foam	53" x 16.25" x 5.25"	51.5" x 14.75" x 4"	1.76	Key Lock	17	2	ABS panel; molded polypropylene two-end cap	Top and bottom foam, pre-perforated cubed foam sheets and keys
BH11982	AX-400 50" Double Sided Rifle Protective Hard Case w/ Foam	53" x 13.5" x 7.75"	each side 52" x 12.25" x 3"	1.11	Key Lock	22	n/a	Aluminum frame and PVC surface	Top and bottom foam, carrying strap and keys

HARD CASES

AX-500 53" WT Rifle Protective Hard Case w/ Wheels and Foam BH12158

Features

- Two carrying handles
- Reinforced wheel rollers

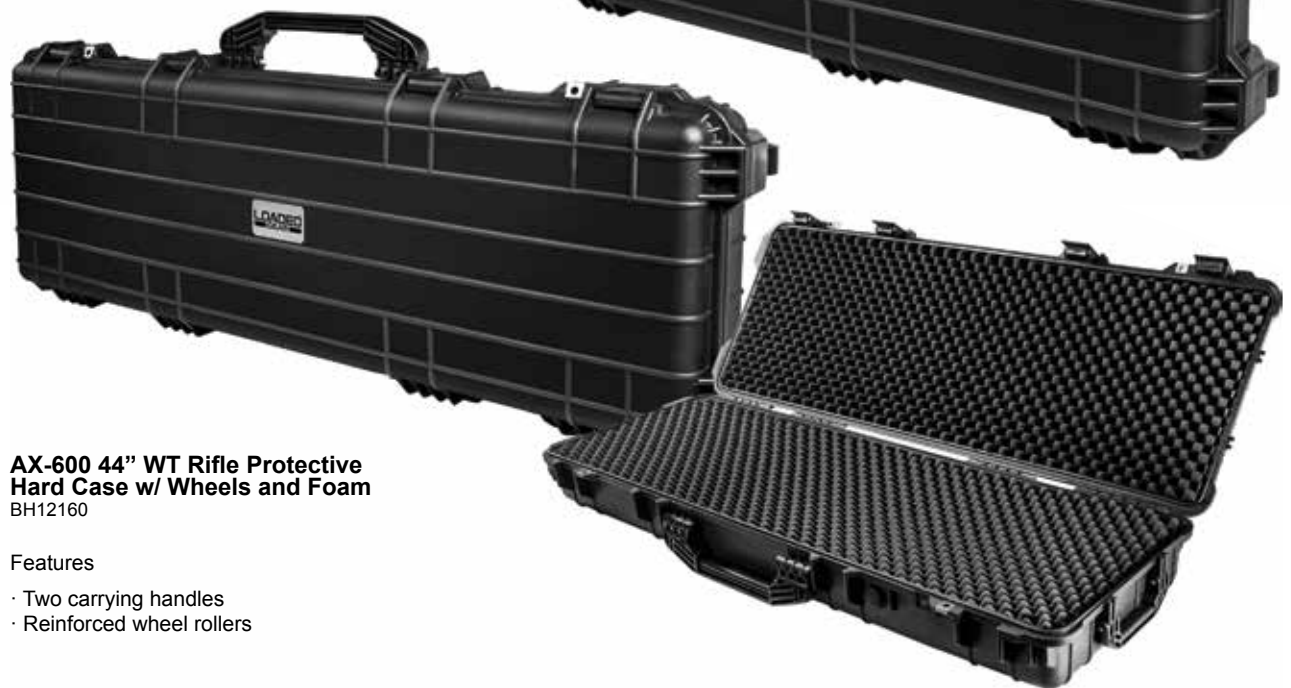

AX-600 44" WT Rifle Protective Hard Case w/ Wheels and Foam BH12160

Features

- Two carrying handles
- Reinforced wheel rollers

Model #	Description	Outer Dimensions L x W x D inches	Inner Dimensions w/o foam	Cubic Feet	Type of Lock	Weight lbs	Tie Down Holes	Material	Includes
BH12158	AX-500 53" WT Rifle Protective Hard Case w/ Wheels and Foam	53" x 15.51" x 6.5"	50" x 13.19" x 5.43"	2.06	Latches	23	2	Polypropylene	Top and bottom foam and two pre-perforated cubed foam sheets
BH12160	AX-600 44" WT Rifle Protective Hard Case w/ Wheels and Foam	44.6" x 16.61" x 6.1"	41.97" x 14.49" x 5.35"	1.9	Latches	20	2	Polypropylene	Top and bottom foam and two pre-perforated cubed foam sheets

HARD CASES

HD-500 WT Protective Hard Case w/Wheels and Foam

BH11864

The Loaded Gear™ HD Pro Hard case is a watertight hard case has been designed with durable ease of use travel features such as built-in solid rollers and extendable travel handle. Features edge-to-edge crushproof protection for secure storage and transportation of valuable equipment. The interior is ideal for protecting and storing valuable bulky equipment such as cameras, optics, laptops and professional equipment. Designed for professional equipment transport, this hard case features an external purge valve for atmospheric pressure equalization. The edge-to-edge crushproof case design is built with anticorrosive material and able to withstand use in the most punishing of weather conditions.

Features

Reinforced wheel rollers | Extendable travel handle | Reinforced crushproof handles | Two padlock mounting points | Watertight and airtight protective case seal | Pressure equalization case valve | Includes two layers of pre-perforated cubed foam and two layers of egg crate case foam padding



HD-200 WT Protective Hard Case w/ Foam, Dark Earth

BH12174

HD-200 WT Protective Hard Case w/ Foam, Yellow

BH12670

HD-200 WT Protective Hard Case w/ Foam

BH11858



HD-150 WP Protective Hard Case w/ Foam

BH12560

HD-100 WT Protective Hard Case w/ Foam

BH11856



Model #	Description	Outer Dimensions LxWxD inches	Inner Dimensions w/o foam	Cubic Feet	Weight lbs	Locks	Tie Down Holes	Material	Includes
BH11864	HD-500 WT Protective Hard Case w/ Wheels and Foam	20.87" x 13.97" x 8.86"	20.07" x 11.5" x 7.01"	0.92	10.19	2	2	Polypropylene	Top and bottom foam and two pre-perforated cubed foam sheets
BH11858	HD-200 WT Protective Hard Case w/ Foam	13" x 11.02" x 4.72"	11.81" x 8.66" x 3.98"	0.21	3.57	2	2	Polypropylene	Top and bottom foam and two pre-perforated cubed foam sheets
BH12560	HD-150 WP Protective Hard Case w/ Foam	10.63" x 9.1" x 7.28"	9.56" x 7.16" x 6.15"	0.24	3.55	2	2	Engineer resin and fiber glass	Top and bottom foam and two pre-perforated cubed foam sheets
BH11856	HD-100 WT Protective Hard Case w/ Foam	8.26" x 6.57" x 3.54"	7.32" x 4.83" x 2.95"	0.06	1.25	2	2	Polypropylene	Top and bottom foam and pre-perforated cubed foam sheet
BH11954	HD-10 WT Protective Tablet Hard Case	10.71" x 8.86" x 1.38"	9.5" x 7.4" x 0.7"	0.03	1.45	1	2	ABS and PC	Removable wrist strap

Contents not included

LOADED GEAR

HD-10 WT Protective Tablet Hard Case



HD-10 WT Protective Tablet Hard Case
BH11954

The Loaded Gear™ HD-10 watertight hard case, is designed for protecting tablets and e-readers. Protects tablets up to 9.5"x7.4"x0.7" when traveling and is compact enough to fit in a day bag or backpack. This dry case features an o-ring lining that when secured with the large double grasping exterior latches create a watertight seal. Interior lined in shock absorbing foam that provides interior cushion support and ensuring a snug fit. The piano hinge allows for full use of electronic device. Two padlock mounting points and includes wrist strap

Tablet Case Compatible With

- iPad Air
- iPad Air 2
- iPad 9.7 (2017)
- iPad Pro 9.7 (1st Generation)
- iPad Mini 2, 3 and 4
- Samsung Galaxy Tab S3
- Samsung Galaxy Tab S2
- ASUS Zen Pad 3S 10

Digital media not included. All trademarks and copyrights are the property of their respective owners. Featured brand trademarks are not associated with this product.

Media not included

Model #	Description	Outer Dimensions L x W x D inches	Inner Dimensions w/o foam	Cubic Feet	Weight lbs	Locks	Tie Down Holes	Material	Includes
BH11954	HD-10 WT Protective Tablet Hard Case	10.71" x 8.86" x 1.38"	9.5" x 7.4" x 0.7"	0.03	1.45	1	2	ABS and PC	Removable wrist strap

RX SERIES

RIFLE BAGS

The Loaded Gear™ RX series of rifle bags are built to provide the best possible protection for your rifle. Rifle bags are heavily padded for extra protection for transport or storage. Features additional pockets for accessories, you can be rest assured that items stored will be protected during transport.



RX-50 16” Dual Pistol Case w/4 Mag Pouches
BI12262

Interior Features

Main compartment securely transports two pistols | Magazine pouch with velcro closure | See thru document pouch | Utility pouch with velcro closure | 2” inch perimeter lip

Exterior Features

Four magazine pouches with velcro closures | Two pouches with velcro and zippered closures | Sturdy carrying handle

RX-100 48” Tactical Padded Rifle Bag, Dark Earth
BI12334

RX-100 48” Tactical Padded Rifle Bag, OD Green
BI12320

Interior Features

Main compartment securely transports one rifle | Padded interior | Hold down straps to keep items in place

Exterior Features

Four section magazine pouches with velcro closures | Large zippered accessory pouch | Reinforced carrying handle | Includes detachable adjustable shoulder strap

RX-100 42” Tactical Padded Rifle Bag
BI13114

Firearms not included

Model #	Description	Outer Dimensions LxWxH inches	Weight lbs
BI12262	RX-50 16” Dual Pistol Case w/4 Mag Pouches	16” x 3.5” x 9”	1.20
BI12334	RX-100 48” Tactical Padded Rifle Bag	48” x 2.3” x 9”	2.85
BI13114	RX-100 42” Tactical Padded Rifle Bag	42” x 2.3” x 9”	2.35



BARSKA® LOADED GEAR™

RX DUAL RIFLE BAG

SERIES

RX-200 45.5" Tactical Dual Rifle Bag
BI12030

RX-200 45.5" Tactical Dual Rifle Bag, OD Green
BI12322

Interior Features

Main compartment securely transports two rifles up to 45.5" long | 3" padded interior perimeter lip | Padded interior | Padded divider | Hold down straps to keep items in place

Exterior Features

One large pocket with two velcro pockets and two zippered pockets | Three utility pockets with velcro and buckle closures | Side compression straps | Detachable adjustable padded backpack straps with sternum strap | Reinforced carrying handle | Velcro area for attaching patches or name tapes





RX-300 40" Tactical Rifle Bag w/MOLLE Webbing
BI12032

RX-300 40" Tactical Rifle Bag w/MOLLE Webbing, Dark Earth
BI12338

RX-300 40" Tactical Rifle Bag w/MOLLE Webbing, OD Green
BI12324

Interior Features

Main compartment transports one rifle up to 40" long | Padded interior unfolds flat into a shooter's mat | Numerous pockets with either buckle or velcro closures

Exterior Features

Heavy duty zipper and buckle closures | Webbing across the front panel for attaching additional items | Reinforced carrying handle | Includes detachable adjustable shoulder strap



RX-600 46" Tactical Dual Rifle Bag
BI12550

RX-600 46" Tactical Dual Rifle Bag, Dark Earth
BI12552

RX-600 46" Tactical Dual Rifle Bag, OD Green
BI12554

Interior Features

Main compartment transports two rifles up to 46" long | Padded center divider | Hold down straps to keep items in place | Utility pouch | 2.5 inch padded interior perimeter lip

Exterior Features

Heavy duty zipper and buckle closures | Four zippered pockets with webbing across the front panel for attaching additional items | Reinforced carrying handle | Includes detachable adjustable shoulder strap and back pack straps



RX-800 12" Dual Pistol Case
BI13226

Interior Features

Fully padded main compartment | Securely transports two pistols | Two inside sleeves with a velcro closure | Front small compartment with five heavy duty elastic magazine holders

Exterior Features

Front small compartment with zippered built-in pocket | Heavy duty double lockable zippers

Model #	Description	Outer Dimensions L x W x H in inches	Weight lbs
BI12030	RX-200 45.5" Tactical Dual Rifle Bag	45.5" x 3.34" x 11.4"	6.61
BI12032	RX-300 40" Tactical Rifle Bag w/MOLLE Webbing	40" x 2" x 15" open flat with mat length 67" x width 31.5"	5.35
BI12550	RX-600 46" Tactical Dual Rifle Bag	46" x 5" x 11.5"	6.7
BI13226	RX-800 12" Dual Pistol Case	12" x 4.5" x 9"	1

Firearms not included

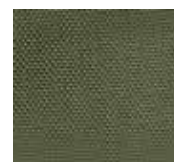

OD Green

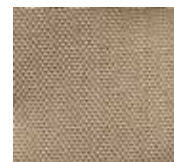

Dark Earth



GX-200 Tactical Backpack
BI12022

GX-200 Tactical Backpack, Dark Earth
BI12342

2 main compartments and 1 smaller compartment | Ergonomic S-curve padded shoulder straps | Front and side 1" web system for attaching extra accessories | Reinforced top carrying handle for an alternative carrying position | Padded back | Large velcro area for attaching patches or name tapes | Side compression straps and sternum straps for the chest and padded waist belt



GX-400 Crossover Low Profile Backpack, Gray
BI12604

1 main compartment and 4 smaller compartments | Ergonomic S-curve padded shoulder straps | Front and side 1" web system for attaching extra accessories | Reinforced top carrying handle for an alternative carrying position | Padded back | Side compression straps | Sternum straps | Waist strap | Reinforced bottom | Laptop compartment that fits up to 12" laptop



GX-500 Crossover Utility Backpack
BI12612

GX-500 Crossover Utility Backpack, Dark Earth
BI12614

1 main compartment and 2 smaller compartments | Ergonomic S-curve padded shoulder straps | Front and side 1" web system for attaching extra accessories | Reinforced top carrying handle for an alternative carrying position | Padded back | Velcro area for attaching patches or name tapes | Internal padded sleeve | Side compression straps | Sternum straps | Padded waist belt with zippered pockets | Laptop compartment that fits up to 17" laptop



GX-600 Crossover Long Range Backpack
BI12598

GX-600 Crossover Long Range Backpack, Dark Earth
BI12600

2 main compartment and 4 smaller compartments | Ergonomic S-curve padded shoulder straps | Front and side 1" web system for attaching extra accessories | Reinforced top and bottom carrying handle for an alternative carrying positions | Quick access section | Padded back | Velcro area for attaching patches or name tapes | Internal padded sleeve | Side compression straps | Sternum straps | Padded waist belt | Laptop compartment that fits up to 15" laptop

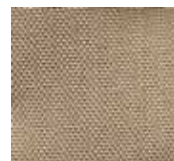

Dark Earth

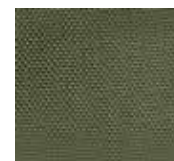

OD Green

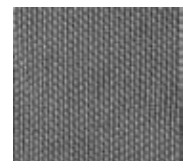

Gray

Model #	Description	Outer Dimensions L x W x H inches	Weight lbs
BI12022	GX-200 Tactical Backpack	13.75" x 7" x 19.3"	2.86
BI12604	GX-400 Crossover Low Profile Backpack	8" x 9.9" x 16"	2.6
BI12612	GX-500 Crossover Utility Backpack	10" x 7" x 17.72"	2.75
BI12598	GX-600 Crossover Long Range Backpack	13" x 9.84" x 19.69"	3.4

TACTICAL VESTS



OD Green

Dark Earth

VX SERIES

TACTICAL VESTS

The Loaded Gear™ VX series includes a full-line of molle tactical vests, plate carrier vests, light & heavy carrier pack vests and chest rigs. Designed to tactical specifications the Loaded Gear tactical vest has superior features to out perform many standard-shooting vests. We push the limits of quality and performance to develop truly the best tactical vests. Tactical vests are now popular for sport shooting, hunting and have been used as airsoft tactical vests.

VX-100 Tactical Vest and Leg Platform
BI12016

VX-100 Tactical Vest and Leg Platform, OD Green
BI12330

VX-100 Tactical Vest and Leg Platform, Dark Earth
BI12344



VX-200 Tactical Vest, Plus Size
BI13196

VX-200 Tactical Vest, Right Hand
BI12018

VX-200 Tactical Vest, Dark Earth
BI12346

VX-200 Tactical Vest, OD Green
BI12332

VX-200 Tactical Vest, Left Hand
BI12154



11 piece web system vest | Fully adjustable to fit most adult body types | Tough mesh webbing designed for maximum ventilation and durability | Webbing system allows for easy re-configurations | Front and back velcro areas for attaching ID patches | Reinforced rescue pull handle located on the upper back of vest | D-rings located on either shoulder | Interior back features a tough mesh pocket for additional items | 11 pieces include, 2 utility pouches, 2 web system double section rifle magazine pouches, 2 adjustable drop leg platforms, radio/phone pouch, double section pouch, belt, detachable dump pouch and detachable right hand draw holster | Vest 22" long, leg platform 18" long (adjustable)

4 piece tactical vest | Fully adjustable to fit most adult body types | Tough mesh webbing designed for maximum ventilation and durability | Webbing system to carry additional gear | Front and back velcro areas for attaching ID patches | Reinforced rescue pull handle located on the upper back of vest | 2 internal zippered pockets for additional items | D-rings on either shoulder | Padded sniper shoulder | Radio/phone pouch | 4 rifle magazine pouches | Utility pouch with detachable elastic loops for shotgun shells | Detachable pieces include draw holster, three section pouch with velcro closures and belt with pouches



VX-300 Tactical Vest
BI12256

VX-300 Tactical Vest, OD Green
BI12286

7 piece tactical vest | Fully adjustable to fit most adult body types | Tough mesh webbing designed for maximum ventilation and durability | Webbing system allows for easy re-configurations | Front velcro area for attaching ID patches | Reinforced rescue pull handle located on the upper back of vest | Internal sleeves for body armor plates located on the back and front of the vest (body armor plates not included) | Internal sleeves feature hold down straps so plates stay in place | Radio/phone pouch | Magazine pouches | Detachable pieces large accessory pouch, three section mag pouch, two section mag pouch, two smaller pouches and accessory pouch with velcro patches

VX-300 Tactical Vest, Dark Earth
BI12308



VX-400 Tactical Chest Rig
BI12258

VX-400 Tactical Chest Rig, OD Green
BI12794

VX-400 Tactical Chest Rig, Dark Earth
BI12792

Split front chest rig with cross back | Internal sleeve for body armor plate located on the front of the vest (body armor plates not included) | Fully adjustable to fit most adult body types | Tough mesh webbing designed for maximum ventilation and durability | Webbing system to carry additional gear | Internal mesh pocket for additional items | D-rings on either shoulder | Padded shoulder straps with webbing | Side storage on sides | 3 mag stacker | 6 accessory pouches for additional items



VX-500 Plate Carrier Tactical Vest
BI12260

VX-500 Plate Carrier Tactical Vest, OD Green
BI12290

Internal sleeves for body armor plates located on the back and front of the vest (body armor plates not included) | Side storage on sides | Adjustable internal cummerbund | One small and one large front pocket located on the front of the vest | Adjustable to fit most adult body types | Tough mesh webbing designed for maximum ventilation and durability | Webbing system to carry additional gear | Front and back velcro areas for attaching ID patches | Reinforced rescue pull handle located on the upper back of vest | Internal mesh pocket for additional items | Detachable shoulder pads

Firearms not included

Model #	Description	Dimensions	Weight lbs
BI12016	VX-100 Tactical Vest and Leg Platform	Vest 22 inches long Adjustable, 38-to-50-inch torso	6.6
BI12018	VX-200 Tactical Vest Adult S - XL	22 inches long Adjustable, 38-to-50-inch torso	3.15
BI13196	VX-200 Tactical Vest, Plus Size Adult 2XL - 4XL	24 inches long Adjustable, 51-to-62-inch torso	3.4
BI12256	VX-300 Tactical Vest	22 inches long Adjustable, 38-to-50-inch torso	4.60
BI12258	VX-400 Tactical Chest Rig	22 inches long Adjustable, 48-to-64-inch torso	1.95
BI12260	VX-500 Plate Carrier Tactical Vest	20.5 inches long Adjustable, 44-to-57-inch torso	2.50

CX SERIES

TACTICAL GEAR

CX-100 Single Point Rifle Sling
BI12034



CX-100 Single Point Sling, Dark Earth
BI12788

CX-100 Single Point Sling, OD Green
BI12790

Single point sling to secure your AR-15 or similar style rifle | Allows full support-side shouldering and shooting for tactical cornering | Fully adjustable | High density elastic bungee style | Quickly detaches | 20" in length

CX-150 Double Point Rifle Sling
BI13198



Double point sling to secure your AR-15 or similar style rifle | Two metal & swirl wide opening clips | Elastic covers for metal clips | Removable shoulder pad | Adjustable length up to 58" | High density elastic bungee at two ends | Two quick-release buckles

CX-300 Drop Leg Dump Pouch
BI12248



Velcro top closure can be configured so the flap stays open | Adjustable height | 2 adjustable leg rig straps with anti-slip rubber stitching | 1 pouch for additional accessories



CX-200 Triple Magazine Pouch
BI12246

CX-200 Triple Magazine Pouch, OD Green
BI12276



3 section magazine holder | Bungee retention straps to adjust for short or tall mags | Front and back features webbing system

CX-400 Elbow and Knee Pads
BI12250

CX-400 Elbow and Knee Pads, OD Green
BI12280



Strong durable design to protect against shock | Allows maximum flexibility for ease of movement and comfort | Adjustable velcro straps | Soft cushion pad on inner side | Perfect for all outdoor activities, sports, shooting games and hunting | Includes mesh carrying bag

CX-600 Tactical Belt
BI12254

CX-600 Tactical Belt, Dark Earth
BI12306

CX-600 Tactical Belt, OD Green
BI12284



Quick-release buckle | 2 removable pouches for additional accessories | 2" wide | Fits up to 44" inch waist

CX-700 Drawstring Dump Pouch, Dark Earth
BI12626

CX-700 Drawstring Dump Pouch, Gray
BI12628



Draw string top closure for main compartment | Front pouch with velcro closure for additional accessories | Side sections for storing smaller items | 2 back snaps for attachment | Back features webbing system

CX-800 Accessory Pouch, Dark Earth
BI12632

CX-800 Accessory Pouch, Gray
BI12634



One main compartment | Front pouch with velcro closure for additional accessories | 2 back snaps for attachment

CX-850 Double Section Mag Pouch
BI13000

CX-850 Double Section Mag Pouch, Dark Earth
BI13002

CX-850 Double Section Mag Pouch, OD Green
BI13004



2 Section magazine holder | Bungee retention straps adjust to fit sort or tall magazines | Front and back feature webbing attachment system | Fits up to 2 standard 30 round rifle magazines

CX-900 First-Aid Utility Pouch, Dark Earth
BI13008

CX-900 First-Aid Utility Pouch, OD Green
BI13010



Full zipper clamshell opening | Reinforced carry handle and D-rings | Internal pockets for storing and organizing supplies | 2 Back snaps for attachment | Velcro section for ID patches

CX-950 Single Rifle & Pistol Mag Pouch, Dark Earth
BI13014

CX-950 Single Rifle & Pistol Mag Pouch, OD Green
BI13016



Open-top design with bungee cord retainer | Fits 2 stacked M4/M16 30 round magazines | 2 Standard pistol magazine pouches | 2 Back snaps for attachment



Dark Earth



OD Green

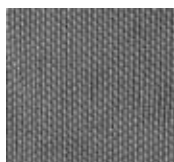

Gray

Model #	Description	Outer Dimensions LxWxH inches	Weight lbs
BI12034	CX-100 Single Point Rifle Sling	1.5 inch wide strap	.20
BI13198	CX-150 Double Point Rifle Sling	1.25 inch wide strap	.5
BI12246	CX-200 Triple Magazine Pouch	9.75 x 6.5 x 1	.55
BI12248	CX-300 Drop Leg Dump Pouch	9 x 4.5 x 9.5	1
BI12250	CX-400 Elbow and Knee Pads	Elbow 5 x 2 x 6.5 Knee 6.5 x 2 x 9	1
BI12252	CX-500 Drop Leg Handgun Holder	4.5 x 2 x 7.5	.95
BI12254	CX-600 Tactical Belt	2 inch wide strap	.60
BI12626	CX-700 Drawstring Dump Pouch	5.5 x 3 x 7.5	.4
BI12632	CX-800 Accessory Pouch	3.5 x 1.25 x 5.6	.2
BI13000	CX-850 Double Magazine Pouch	5.5 x 6.3	.3
BI13008	CX-900 First-Aid Utility Pouch	7 x 5.5 x 2.4	.45
BI13014	CX-950 Single Rifle & Pistol Mag Pouch	5.5 x 3.4	.3

BARSKA® BINOCULARS



BARSKA Binoculars

Experience high definition viewing with the Level HD and Level ED series of binoculars. The binoculars are o-ring sealed and dry nitrogen purged for waterproof and fogproof protection, which allows for stunning viewing clarity in any weather condition. BARSKA's Battalion tactical style binocular series are six ruggedly-designed designed to meet tactical standards. The Gladiator series are a high power zoom binocular that are ideal for long distance terrestrial (land) or celestial (sky) viewing. From compact to "jumbo" there is a BARSKA binocular for every pursuit and they all share this in common -- BARSKA's reputation for value, quality and new technology. Whether at a sporting event, hunting or just enjoying nature you'll make the most of your viewing with a BARSKA high performance binocular.

BINOCULAR TERMINOLOGY

Binoculars are available in a wide variety of sizes, powers and features for different usage and purposes. A binocular consists of two optical systems that are connected by a hinge sharing a common focus system. By using a binocular, an image can be projected simultaneously for both eyes providing a realistic perception of depth.

PRISM SYSTEM/TYPE

The prism system of a binocular reduces the size of a long optical path and correct an inverted image. There are three most common types of prism construction.

Roof Prism System

The prisms overlap and are aligned in a straight line with the lenses allowing to have a slim construction.

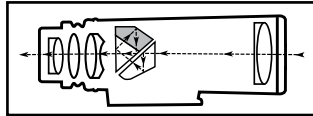

Porro Prism System

The objective is offset from the eyepiece offering greater depth perception and a wider field of view.

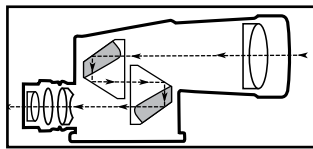

Reverse Porro System

The objectives are offset from the eyepiece in a horizontal way reducing the total size of the construction by about 30% compared to the traditional porro prism system.

PRISM GLASS

The common standards of optical prisms are barium-crown (BAK-4) glass or borosilicate (BK-7) glass. The BAK-4 is a higher quality glass that reduces light scattering, resulting in sharper and brighter images.

MAGNIFICATION (POWER)

Magnification is the number of times the object being viewed is enlarged. Binoculars are often identified by two numbers, for example: 10x50. The first number indicates the magnification or the power of the binocular, expressed by the letter "x", for times. This means that the object being viewed appears to be 10 times closer than would be seen with the naked eye.



OBJECTIVE LENS DIAMETER

The second number in the reference (i.e. 10x50) indicates the diameter of the objective lens or the front lens. The larger the objective lens, the better the light transmission, thus the brighter the image.

BINOCULAR FEATURES

Wide Angle

Binoculars with a wider field of view. This wide-angle feature is better for capturing action or fast sports.

Zoom

Zoom binoculars have variable powers of magnification allowing you to view closer in the distance without changing binoculars.

WATERPROOF/FOGPROOF

Waterproof binoculars are O-ring sealed for waterproof protection to keep dry inside after immersion in water. Some binoculars are also fogproof which means that they are nitrogen-purged to prevent anti-fogging inside the optical surfaces.

OPTICAL COATINGS

Various coating processes on the lenses and prisms will determine the brightness and the light gathering of a binocular, providing higher contrast and brighter images. The different types of coating are:

Coated – A single layer on at least one lens surface

Fully Coated – A single layer on all air-to-glass lens surfaces

Multi-Coated – Multiple layers on at least one lens surface

Fully Multi-Coated – Multiple layers on all air-to-glass surfaces

FIELD OF VIEW (F.O.V)

This is the side-to-side linear measurement of the of the circular field seen through a binocular. It is defined by the width in feet of the area visible at 1000 yards, or in meters at 1000m. The higher the magnification, the narrower the field of view.

CLOSE FOCUS DISTANCE

The closest distance to the observed object that the binoculars can be used while retaining a sharp focus.

RESOLUTION

The measurement of the binocular's ability to distinguish fine detail and sharpness.

EXIT PUPIL

This refers to the size of the small disc of light visible at the eyepiece of a binocular. To determine the size of the exit pupil, divide the objective diameter by the power: For example, a 10x50 binocular will have an exit pupil of 5mm

EYE RELIEF

This is the distance a binocular can be held away from the human eye and can still observe the entire field of view. Long Eye Relief (LER) reduces eyestrain and is more comfortable for eyeglass wearers.

FOCUS SYSTEM

The mechanism that is used to focus both barrels of a binocular on the object being viewed. They are normally three types of focus systems.

Center Focus – Where the focusing knob is located in the center of the binocular

Individual Focus – Where the focusing knob is located individually in each eyepiece

Fixed focus – No focusing required

DIOPTR ADJUSTMENT

A ring adjustment for fine-focusing which is usually provided around one eyepiece. This allows to compensate for vision difference between the right and left eye.



Rubber fold-down



Twist-up

EYECUPS

The most common eyecups are twist-up, pop-up, or rubber fold-down.

BINOCULAR LIMITED LIFETIME WARRANTY

(Within USA and Canada only)

This warranty does not cover consumer-caused damages, abuse, normal wear-and-tear, unauthorized repairs or modifications. For further detailed information, please refer to the warranty policy enclosed with products.



10x34 WP
AB12524



10x42 WP
AB12528



10x26 WP
AB12520



The Air View series of binoculars was designed to be the go-to choice for someone who is looking for a lightweight compact binocular. This series of binoculars will easily fit into a pocket or backpack without taking up too much space. Nitrogen-purged body that is waterproof and fogproof, non-slip and shock absorbing rubber armor proves a firm grip. Ideal for hiking, bird watching, and other outdoor activities. The Air View Series utilizes fully multi-coated lenses and BAK-4 prisms to ensure high quality viewing in any lighting situation. Fully multi-coated lenses are designed to maximize light transmission and deliver an exceptionally clear view to the user. A key feature of the Air View Series is the open bridge design, which gives the viewer long-term viewing comfort while providing a better finger hold for gripping. This helps stabilize your view during use, especially over longer periods of time. Includes carrying case, neckstrap and are protected by BARSKA's limited lifetime warranty.

Air View Features

O-Ring sealed for waterproof protection | Dry nitrogen-purged and sealed to prevent fogging, clouding and moisture damage | Open bridge design | Fully multi-coated optics to maximize light transmission for brighter images | BAK-4 prisms for crisp and clear images | Twist-up eyecups | Large center focus knob | Rugged shock-absorbing rubber armor | Tripod adaptable fittings | Non-slip and ergonomic design for a secure grip | Includes carrying case and neck strap | Limited Lifetime Warranty

Model #	Magnif.	Objective Lens (mm)	Prism Type	Prism Glass	Exit Pupil (mm)	Optical Coating	Focus System	Field of View (ft@1000yds/m@1000m)	Close Focus (ft/m)	Eye Relief (mm)	Weight (oz.)
AB12528	10x	42	Roof	BAK-4	4.2	Fully Multi Coated	Center	319/106	13.12/4	16.1	20
AB12524	10x	34	Roof	BAK-4	3.3	Fully Multi Coated	Center	314/105	13.12/4	16	16
AB12520	10x	26	Roof	BAK-4	2.6	Fully Multi Coated	Center	293/89	13.12/4	14.1	7.6

LEVEL HD™



10x42 WP
AB12772

8x42 WP
AB12770



8x32 WP
AB12762

Experience high definition viewing with the Level HD Series of binoculars. The Level HD binoculars combine fully multi-coated lenses with high-quality BAK-4 prisms to deliver an impressively sharp and detailed image. The Level HD binoculars are o-ring sealed and argon purged for waterproof and fogproof protection, which allows for stunning viewing clarity in a wide range of outdoor activities. The Level HD binoculars are perfect for hiking, bird watching, sporting events, and much more. Includes a soft carrying case and neckstrap.

Level HD Features

- O-ring sealed for waterproof protection
- Argon purged and sealed to prevent fogging, clouding and moisture damage
- Fully multi-coated optics for increased clarity
- BAK-4 prisms for crisp images
- Large knurled center focus knob for precise focusing
- Non-slip textured rubber design for a secure grip
- Shock-absorbing rubber armor
- Ideal for all outdoor activities in all-weather conditions
- Includes carrying case and neckstrap
- Limited Lifetime Warranty

Model #	Magnification	Objective Lens (mm)	Prism Type	Prism Glass	Exit Pupil (mm)	Optical Coating	Focus System	Field of View (ft@1000yds/m@1000m)	Close Focus (ft/m)	Eye Relief (mm)	Weight (oz.)
AB12772	10x	42	Roof	BAK-4	4.24	Fully Multi-Coated	Center	303/101	22.3/8	14.6	26.4
AB12770	8x	42	Roof	BAK-4	5.28	Fully Multi-Coated	Center	368/123	8.2/2.5	17.2	24.8
AB12762	8x	32	Roof	BAK-4	4	Fully Multi-Coated	Center	396/132	8.2/2.5	14.8	20.8

LEVEL ED™



10x42 WP AB12804 **8x42 WP** AB12802



10x42 WP AB12992



8x32 WP AB12990

When it comes to delivering top optical performance, the Level ED binoculars excel. Equipped with Extra Low Dispersion (ED) glass, these binoculars maximize image quality to provide an extraordinarily sharp and detailed image. A textured rubber coating provides both protection from external damage and a comfortable non-slip surface for a more secure grip. The optical quality of the Level ED binoculars is further enhanced with BAK-4 prisms for increased clarity. The Level ED binoculars come with a soft carrying case and a neckstrap.

Level ED Features

- Extra Low Dispersion (ED) glass for enhanced image quality
- O-ring sealed for waterproof protection
- Argon purged and sealed to prevent fogging
- Multi coated optics for increased clarity
- BAK-4 prisms for crisp images
- Large knurled center focus knob for precise focusing
- Non-slip textured rubber design for a secure grip
- Shock-absorbing rubber armor
- Ideal for all outdoor activities in all-weather conditions
- Includes carrying case and neckstrap
- Limited Lifetime Warranty

Model #	Magnification	Objective Lens (mm)	Prism Type	Prism Glass	Exit Pupil (mm)	Optical Coating	Focus System	Field of View (ft@1000yds/m@1000m)	Close Focus (ft/m)	Eye Relief (mm)	Weight (oz.)
AB12804	10x	42	Roof	BAK-4	4.24	Fully Multi-Coated	Center	341/114	6/1.9	15.5	26.4
AB12802	8x	42	Roof	BAK-4	5.25	Fully Multi-Coated	Center	425/142	6/1.9	17.5	24.8
AB12992	10x	42	Roof	BAK-4	4.24	Fully Multi-Coated	Center	425/141	2	17.2	24.8
AB12990	8x	32	Roof	BAK-4	4	Fully Multi-Coated	Center	416/138	2	15.6	17.6



See what you have been missing with the Level Series by Barska. The zoom and monocular models that provide high-quality viewing and the durable rubber-armored coating ensures a non-slip grip. The smooth knob makes these series simple to operate and easy to focus. This versatile series makes them well suited for a wide range of activities, such as bird watching, sporting events, concerts, hunting, and more. Coated lenses delivers optimal brightness, resolution, and contrast for high-quality viewing in all kinds of lighting environments. Comes complete with a soft carrying case and a strap. You can rely on these binoculars thanks to the rugged construction and Barska's Limited Lifetime Warranty.

Features

Coated optics to maximize light transmission for brighter images | BK-7 or BAK-4 prisms for crisp and clear images | Center focus knob | Rugged shock-absorbing rubber armor | Non-slip and ergonomic design for a secure grip | Includes carrying case and strap | Limited Lifetime Warranty



10-30x50
AB12534



7-15x35
AB12530



16x50
AB12236



12x60
AB12466



8x40
AB12234



8x32 WP
AA12536

Model #	Magnif.	Objective Lens (mm)	Prism Type	Prism Glass	Exit Pupil (mm)	Optical Coating	Focus System	Field of View (ft@1000yds/m@1000m)	Close Focus (ft/m)	Eye Relief (mm)	Weight (oz.)
AB12534	10-30x	50	Porro	BAK-4	5	Fully Multi Coated	Center	198/66@10x	26.24/8	19-16	32
AB12530	7-15x	35	Porro	BAK-4	5	Fully Multi Coated	Center	288/96@7x	16.4/5	18-15.5	24
AB12236	16x	50	Porro	BK-7	3.1	Fully Multi Coated	Center	216/72	26.24/8	13.3	28.8
AB12466	12x	60	Porro	BK-7	5	Fully Multi Coated	Center	288/96	29.52/9	17.5	36.8
AB12234	8x	40	Porro	BK-7	5	Fully Multi Coated	Center	429/143	16.4/5	18	19.2
AA12536	8x	32	Roof	BK-7	3	Multi Coated	Center	394/131	6.56/2	13.6	10.4

CROSSOVER | Binoculars



10x42 WP
Mossy Oak® Blaze®
 AB13437

Blend in with Mossy Oak® Blaze® camouflage. A highly visible pattern to the human eye that matches hunting regulation safety orange, with low visibility to prey.



10x42 WP
 AB13502



8x30 WP
 AB13530



Engineered to perform at its best under harsh conditions, these binoculars are truly the next generation of binoculars. Features BAK-4 prisms and are fully multi coated optics that result in remarkably bright images. Featuring nitrogen-purged body that is waterproof and fogproof, non-slip and shock absorbing rubber armor proves a firm grip. Adjustments such as twist-up eyecups and right eye diopter let you customize these binoculars to your personal preference. Whether your hiking, birdwatching, or hunting these binoculars will crossover from one environment to the next. Includes carrying case, neckstrap and are protected by BARSKA's limited lifetime warranty.

Crossover Features

O-Ring sealed for waterproof protection | Dry nitrogen-purged and sealed to prevent fogging, clouding and moisture damage | Fully multi-coated optics to maximize light transmission for brighter images | BAK-4 prisms for crisp and clear images | Twist-up eyecups | Large center focus knob | Rugged shock-absorbing rubber armor | Tripod adaptable fittings | Non-slip and ergonomic design for a secure grip | Includes carrying case and neck strap | Limited Lifetime Warranty

Model #	Magnification	Objective Lens (mm)	Prism Type	Prism Glass	Exit Pupil (mm)	Optical Coating	Focus System	Field of View (ft@1000yds/m@1000m)	Close Focus (ft/m)	Eye Relief (mm)	Weight (oz.)
AB13437	10	42	Porro	BAK-4	4.2	Fully-Multi	Center	315/105	16/5	17.5	23.28
AB13502	10	42	Porro	BAK-4	4.2	Fully-Multi	Center	315/105	16/5	17.5	23.28
AB13530	8	30	Porro	BAK-4	3.75	Fully-Multi	Center	431/144	8/2.5	17.6	20.36

CRUSH series

10x42
AB12978



10x42
AB12976



10x42
AB12974



The Crush Series of binoculars deliver high quality optics in a bright and colorful package. With fully multi-coated optics and high-quality BAK-4 prisms, the Crush binoculars are well-equipped to provide outstanding viewing performance. The colorful protective rubber coating protects the Crush binoculars from shock and impact while providing a comfortable non-slip surface for ensuring a secure grip. These lightweight binoculars come with a neckstrap and soft carrying case, and are a great accessory for concerts, hikes, vacations, and much more. See what you have been missing with the all-new Crush Series of binoculars from Barska.

Crush Features

A variety of colors to choose from | Fully multi-coated optics to maximize light transmission for brighter images | BAK-4 prisms for crisp and clear images | Twist-up eyecups | Large center focus knob | Rugged shock-absorbing rubber armor | Tripod adaptable fittings | Non-slip and ergonomic design for a secure grip | Includes carrying case and neck strap | Limited Lifetime Warranty

Model #	Magnif.	Objective Lens (mm)	Prism Type	Prism Glass	Exit Pupil (mm)	Optical Coating	Focus System	Field of View (ft@1000yds/m@1000m)	Close Focus (ft/m)	Eye Relief (mm)	Weight (oz.)
AB12974	10x	42	Roof	BAK-4	4.2	Fully Multi Coated	Center	305/102	6.56/2.5	13.6	19.2
AB12976	10x	42	Roof	BAK-4	4.2	Fully Multi Coated	Center	305/102	6.56/2.5	13.6	19.2
AB12978	10x	42	Roof	BAK-4	4.2	Fully Multi Coated	Center	305/102	6.56/2.5	13.6	19.2

25x100 WP

AB13642

- Braced-in tripod-mounting post
- Includes premium soft case that can easily convert into a backpack



20x80 WP

AB13640

- Braced-in tripod-mounting post
- Includes premium soft case that can easily convert into a backpack



Enjoy sights that are out of this world. If you want to immerse yourself and take in the vastness of the world around you and the Universe, you need a binocular that will take you there. Super-large objective lenses coupled with high-powered magnification, combined with premium optics, the Cosmos series imposes a lasting impression of strength and precision. Cosmos boasts outstanding performance especially for astronomical viewing and long distance terrestrial observation at low-light conditions. Cosmos feature heavy-duty and reinforced construction.

Cosmos Features

Waterproof protection | High power magnification | Multi-coated Optics | BAK-4 prisms for crisp and clear images | Long eye relief | Individual eyepiece focusing | Heavy-duty and structurally reinforced | Large objective lens maximizes light transmission for vivid images | Includes carrying case | Limited Lifetime Warranty

10x50 XWA

AB13380



X-TREME VIEW | Extreme Wide Angle Binoculars

Sporty design and an ultra-wide field of view make X-treme View a great companion for any sporting event, concert or sightseeing adventure. With razor sharp focus, BAK-4 prisms and multi-coated optics, these spectator binoculars go the distance delivering crisp, panoramic views. Long eye relief and foldable eyecups contribute to comfortable viewing and the extreme wide angle keeps more action in sight and are also perfect for viewing breathtaking scenic nature panoramas. Our Xtreme View's distinctive and sporty styling is enhanced with a non-slip and shock absorbing rubber armor covering that is both functional and comfortable.

X-Treme View Features

Ultra wide angle field-of-view | Multi-coated optics for vivid images | BAK-4 prisms for increased clarity | Large knurled center focus knob | Long eye relief with foldable rubber eyecups | Non-slip and shock absorbing armor provides a firm grip | Sporty and contemporary styling | Convenient and handy | Includes carrying case and neckstrap | Limited Lifetime Warranty

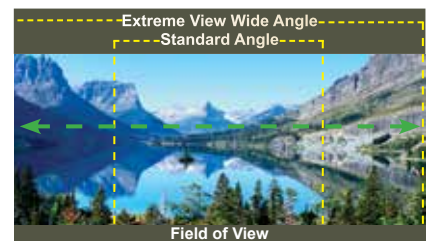

Model #	Magnification	Objective Lens (mm)	Prism Type	Prism Glass	Exit Pupil (mm)	Optical Coating	Focus System	Field of View (ft@1000yds/m@1000m)	Close Focus (ft/m)	Eye Relief (mm)	Weight (oz.)
AB13642	25x	100	Porro	BAK-4	15.4	Multi-Coated	Individual	157/52	55.8/17	15.4	130.8
AB13640	20x	80	Porro	BAK-4	4.0	Multi-Coated	Individual	157/52	39.4/12	15.4	104
AB13380	10x	50	Porro	BAK-4	5.0	Multi-Coated	Center	399/133	19.7/6.0	17.8	36.8



12x42 WP
Mossy Oak® Break-Up®
AB11848

10x42 WP
Mossy Oak® Break-Up®
AB11850, AB11851 Clam

BLACKHAWK

BINOCULARS & MONOCULARS

BLACKHAWK | Waterproof Binoculars

12x42 WP
AB11840,
AB11841, Clam



10x42 WP
AB11842,
AB11843 Clam

8x42 WP
AB11852

10x42 WP
AB13434



10x25 WP
AB11844,
AB11845 Clam



10-30x50
AA13638



10x40 WP
AA12132
AA12133 Clam



10x25 WP
AA12130
AA12131 Clam



Blackhawk binoculars feature a diamond textured cut grip, this grip insures a comfortable and stable viewing experience. The coated optics in this compact roof prism design delivers high quality, clear crisp images. Designed for a wide range of outdoor activities the Blackhawk binoculars are nitrogen purged and o-ring sealed for waterproof / fogproof protection. Comes complete with carrying case and neck strap. Backed by Barska's Limited Lifetime Warranty.

Blackhawk Features

O-ring sealed for waterproof protection | Dry nitrogen-purged and sealed to prevent fogging, clouding and moisture damage | Coated optics for increased clarity | BAK-4 or BK-7 prisms for crisp images | Large knurled center focus knob for precise focusing | Non-slip diamond textured rubber design for a secure grip | Shock-absorbing rubber armor | Ideal for a wide range of outdoor activities | Includes carrying case and neckstrap | Limited Lifetime Warranty

Model #	Magnification	Objective Lens (mm)	Prism Type	Prism Glass	Exit Pupil (mm)	Optical Coating	Focus System	Field of View (ft@1000yds/m@1000m)	Close Focus (ft/m)	Eye Relief (mm)	Weight (oz.)
AB11840	12x	42	Roof	BAK-4	3.5	Multi Coated	Center	275/84	6.6/2	17	25
AB11842	10x	42	Roof	BAK-4	4.2	Multi Coated	Center	344/105	6.6/2	17.5	24
AB13434	10x	42	Roof	BAK-4	4.1	Fully Multi Coated	Center	283/98	13.12/4	14	19.2
AB11852	8x	42	Roof	BAK-4	5.25	Multi Coated	Center	330/110	13/4	21	24
AB11844	10x	25	Roof	BAK-4	2.5	Multi Coated	Center	303/101	16.4/5	14	13.9
AA13638	10-30x	50	Roof	BK-7	4	Fully Coated	Eyeiece	198/66	21.35/6.5	15	15.16
AA12132	10x	40	Roof	BK-7	4	Multi Coated	Eyeiece	344/105	13/4	17.5	4.8
AA12130	10x	25	Roof	BK-7	2.5	Multi Coated	Eyeiece	331/101	13/4	11	15.2

DEEP SEA | Waterproof Binoculars



7x50 WP
AB10160
With internal Rangefinder
and Directional Compass

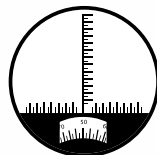

7x50 WP Floating Binocular
AB10798

With internal rangefinder
and directional compass

The Deep Sea Series is designed specifically for the nautical and boating enthusiast. With 7x magnification (most popular size because of the steady image achievable under rough sea conditions) and exceptional optics, these binoculars provide clear views of marine observation from sunrise to sundown. In addition, selected models include an internal rangefinder and directional compass for navigation. The Deep Sea series includes a wide range of seaworthy roof and porro styles and sizes to meet the needs of the experienced or beginning mariner. There's even a Deep Sea model that floats! All Deep Sea models feature a rugged rubber armor covering that provides a sure and secure grip.

Deep Sea Features

O-ring sealed for waterproof protection | Dry nitrogen-purged and sealed to prevent fogging clouding and moisture damage | High quality optics for increased clarity | BAK-4 or BK-7 prisms | Non-slip and ergonomic rubber design for a secure grip | Heavy-duty and shockproof rubber armor | Ideal a wide range of outdoor activities | Specially designed for nautical use | Includes carrying case and neck strap | Limited Lifetime Warranty

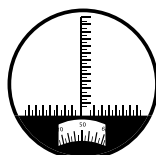

7x42 WP
AA11442

With internal rangefinder
and directional compass

Compass does not operate in southern hemisphere

Model #	Magnification	Objective Lens (mm)	Prism Type	Prism Glass	Exit Pupil (mm)	Optical Coating	Focus System	Field of View (ft@1000yds/m@1000m)	Close Focus (ft/m)	Eye Relief (mm)	Weight (oz.)
AB10798	7x	50	Porro	BAK-4	7.2	Fully Multi-Coated	Individual	395/132	22.3/6.8	23.0	38.8
AB10160	7x	50	Porro	BAK-4	7.2	Fully Coated	Center	350/117	22/7	27.4	43.07
AA11442	7x	42	Roof	BAK-4	6	Fully Multi-Coated	Individual	366/122	42.64/13	19.0	13.4

FLOATING BINOCULARS

Floatmasters eliminate the decision to “sink or swim”. You won’t have to worry about losing your Floatmaster binoculars if they take an unexpected plunge into the water because they are buoyant and float. Compact, lightweight and waterproof, Floatmasters perform brilliantly out of the water. They feature fully coated optics and a textured and rugged rubber armor and rugged rubber armor covering for a secure grip. When you’re on dry land, the Floatmaster is equally at home on a camping excursion, fishing trip, family vacation, or at sporting events.

Floatmaster Features

Waterproof protection | Floats on water | Fully coated optics for bright clear images | Sturdy construction roof prism binoculars | Textured and rugged rubber armor | Non-slip and ergonomic rubber design for secure grip | Compact and lightweight | Includes carrying case and neck strap | Limited Lifetime Warranty



7x50 WP
AB12738



10x30 WP
AB11092



10x30 WP
AB10514



Model #	Magnification	Objective Lens (mm)	Prism Type	Prism Glass	Exit Pupil (mm)	Optical Coating	Focus System	Field of View (ft@1000yds/m@1000m)	Close Focus (ft/m)	Eye Relief (mm)	Weight (oz.)
AB10514	10x	30	Roof	BK-7	3.0	Fully Coated	Center	262/87	32.8/10	14.9	17.0
AB12738	7x	50	Roof	BAK-4	7	Fully Multi Coated	Center	367/122	15/5	23	36.5



8x30 WP
 AB11776
 Internal Rangefinder & IR
 Directional Compass

If it's true that "There's strength in numbers", BARKA's BATTALION tactical style series has the numbers to prove it. Ruggedly designed and larger models are waterproof and fogproof with large objective lenses, fully multi-coated optics, BAK-4 prisms and plenty of magnification. Designed to meet tactical standards, all models are fully rubber armored for shock protection and a comfortable secure grip. Whether you're ashore or on the water, these binoculars are designed to perform in the most demanding conditions. Choose from compact or full-size models with or without an internal rangefinder and compass.

Battalion Features

Variety of models to choose from | Fully multi-coated optics | BAK-4 prisms | Select models feature Internal compass and rangefinder reticle on select models | Magnesium and Aluminum construction on select models | Large ocular lens for comfortable viewing | Designed to meet tactical standards | Individual eyepiece focus | Rubber armor covered | Carrying case and neckstrap | Limited Lifetime Warranty



7x32
 AA11956



8x42
 AA11958

Model #	Magnification	Objective Lens (mm)	Prism Type	Prism Glass	Exit Pupil (mm)	Optical Coating	Focus System	Field of View (ft@1000yds/m@1000m)	Close Focus (ft/m)	Eye Relief (mm)	Weight (oz.)
AA11956	7x	32	Roof	BAK-4	4.57	Fully Multi Coated	Individual	389/130	3.2/1	20.7	7.8
AA11958	8x	42	Roof	BAK-4	5.25	Fully Multi Coated	Individual	357/119	3.2/1	22.5	10.8

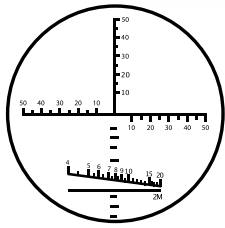

8x30 WP
AB11036
With internal Rangefinding Reticle

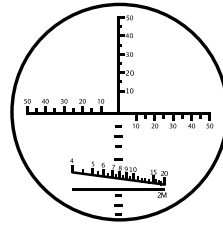

7x50 WP
AB11610
Floating Binocular with internal Rangefinding reticle

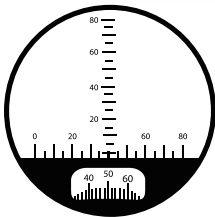

7x50 WP
AB10510
With internal Rangefinder and Directional Compass

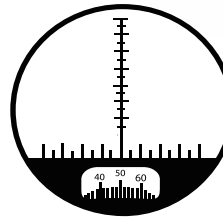

7x50 WP
AB11042
With internal Rangefinder and Directional Compass

Compass does not operate in southern hemisphere

Model #	Magnification	Objective Lens (mm)	Prism Type	Prism Glass	Exit Pupil (mm)	Optical Coating	Focus System	Field of View (ft@1000yds/m@1000m)	Close Focus (ft/m)	Eye Relief (mm)	Weight (oz.)
AB11036	8x	30	Porro	BAK-4	3.75	Fully Multi Coated	Individual	423/141	16.04/5	16.5	20.28
AB11776	8x	30	Porro	BAK-4	3.75	Fully Multi Coated	Individual	423/141	16.04/5	7.1	49.6
AB11610	7x	50	Porro	BAK-4	7.2	Fully Multi Coated	Individual	395/132	22.3/6.8	6.8	38.8
AB10510	7x	50	Porro	BAK-4	7.1	Fully Multi Coated	Individual	396/132	16.04/5	22.8	47.97
AB11042	7x	50	Porro	BAK-4	7.1	Fully Multi Coated	Individual	393/131	16.04/5	25.5	56.43



7-20x35
AB11048
· Zoom Magnification



Tripod Adapter Included



12-60x70
AB11052
· Zoom Magnification



10-30x60
AB11050
· Zoom Magnification



20x50
AB11046

10x50 WA
AB11044

7x50 WA
AB11244

BARSKA's Escape series is a porro prism binoculars designed for all types of outdoor activities. The increased light gathering ability of their large objective lens translates into greater detail and image clarity which is especially useful in low light conditions and at night. Available in a choice of fixed power or zoom, these binoculars are designed for convenience and ease of use. A large center focus knob and eyepiece diopter adjustment make focusing quick and precise. Escape binoculars also feature full rubber armor covering for a comfortable, secure and slip-free grip. Includes a soft carrying case and neckstrap. Limited Lifetime Warranty.

Escape Features

Multi-coated optics for sharp and crisp images | Large objective lens for increased light transmission | Shock-absorbing rubber armor | Zoom magnification (select models) | Tripod-adaptable fittings for a steady view | Ideal for all outdoor activities and sporting events | Includes carrying case and neckstrap | Limited Lifetime Warranty

Model #	Magnification	Objective Lens (mm)	Prism Type	Prism Glass	Exit Pupil (mm)	Optical Coating	Focus System	Field of View (ft@1000yds/m@1000m)	Close Focus (ft/m)	Eye Relief (mm)	Weight (oz.)
AB11052	12-60x	70	Porro	BK-7	5.8-1	Multi-Coated	Center	171/57 @12x, 51/17@60x	49/15	14@12x	52
AB11050	10x-30x	60	Porro	BK-7	6-2	Multi-Coated	Center	186/62@10x, 102/34@30x	42/13	14@10x	40.8
AB11048	7x-20x	35	Porro	BK-7	5-1.7	Multi-Coated	Center	294/98 @7x, 162/54@20x	32/10	14@7x	25.6
AB11044	10x	50	Porro	BK-7	5	Multi-Coated	Center	366 /122	32/10	20	31.7
AB11046	20x	50	Porro	BK-7	2.5	Multi-Coated	Center	174/58	32/10	8	25.6
AB11244	7x	50	Porro	BK-7	5	Multi-Coated	Center	374/114	32.8/10	7.14	31.2

FOCUS FREE | Binoculars

Focus free binoculars are the ideal binoculars for viewing fast paced action. Now you see it. When there's no time to focus when you are trying to catch a glimpse of the fast action, BARSKA's Focus Free binoculars come to the rescue. They provide immediate viewing with no focusing required. These binoculars feature a wide field of view and their fully coated optics will allow you to see the action crisp and clear. With stylish rubber armor and a range of sizes to meet most occasions, the Focus Free series is ideal for long-distance wildlife observation, exciting spectator sports and races. Just pick up the binoculars and view instantly. Focus Free binoculars are perfect for fast movement observation because you do not have to stop and focus on your subject to bring it into view.

Focus Free Features

Simple with no need for any focusing | Fast immediate viewing | Fully coated optics for clear images | Contemporary rubber armor designs | Wide angle field of view on full size models | Ideal for all action-packed activities | Includes carrying case and neckstrap | Limited Lifetime Warranty



10x50
AB10306,
AB10307 Clam



7x35
AB10304



9x25
AB10302,
AB10303 Clam

Model #	Magnification	Objective Lens (mm)	Prism Type	Prism Glass	Exit Pupil (mm)	Optical Coating	Focus System	Field of View (ft@1000yds/m@1000m)	Close Focus (ft/m)	Eye Relief (mm)	Weight (oz.)
AB10306	10x	50	Porro	BK-7	5	Fully Coated	Free	367/122	25/8	15.0	26.0
AB10304	7x	35	Porro	BK-7	5	Fully Coated	Free	420/140	20/6	13.0	20.0
AB10302	9x	25	Roof	BK-7	2.8	Fully Coated	Free	299/100	16/5	10.0	6.2

TREND | Monocular

Monoculars can be fashionable too! That's the Trend contemporary monocular that is compact and lightweight revamped with an updated look. Sleek and stylish, ergonomic with non-slip rubber armor, Trend appeals to all ages. With their good looks and vivid images, they are ideal for outdoor events, travel, and gifts. Set a new trend!

Trend Features

Stylish and ergonomic rubber armor with silver accent | Ideal for travel, concerts and sporting events | Fully and multi-coated optics for vivid images | Sleek and fashionable | Compact and lightweight | Includes carrying case and neckstrap | Limited Lifetime Warranty



10x25
AA10196

Model #	Magnification	Objective Lens (mm)	Prism Type	Prism Glass	Exit Pupil (mm)	Optical Coating	Focus System	Field of View (ft@1000yds/m@1000m)	Close Focus (ft/m)	Eye Relief (mm)	Weight (oz.)
AA10196	10x	25	Roof	BK-7	2.5	Fully Coated	Eyeiece	288/96	26/8	10.5	3.88

GLADIATOR BINOCULARS

BY BARSKA®



25-125x80

AB10594

Braced-in tripod
mounting post



20-140x80

AB11184

Braced-in tripod
mounting post

ASTRONOMY And
LONG DISTANCE VIEWING

The Gladiator Series offers a selection of zoom models that are ideal for long distance terrestrial (land) or celestial (sky) viewing. The wide variable magnification range of these binoculars allows the viewer to target in on an object and then zoom in and magnify it to obtain a closer look and see greater detail as well as fold-down eyecups for viewing with or without eyeglasses.

Gladiator Features

Powerful zoom with different magnifications | Quality coated optics for sharp and crisp images | Large objective lens for increased light transmission for brighter images | Shock-absorbing rubber armor | Ruby lens to minimize UV glare on selected models | Tripod-adaptable fittings for a steady view (select models) | Ideal for all outdoor activities and sporting events | Includes carrying case and neckstrap | Limited Lifetime Warranty

Accessories sold separately



20-100x70
AB10592
Tripod Adapter
Included



12-60x70
AB10172
12-36x70
AB10170
Tripod Adapter
Included



10-30x60
Ruby Lens
AB10762



10-30x50
Reverse Porro
AB13372



10-30x50
Ruby Lens
AB10168,
AB10169 Clam



8-24x50
Ruby Lens
AB11180

9-27x25
AB12542



Model #	Magnifi.	Objective Lens (mm)	Prism Type	Prism Glass	Exit Pupil (mm)	Optical Coating	Focus System	Field of View (ft@1000yds/m@1000m)	Close Focus (ft/m)	Eye Relief (mm)	Weight (oz.)
AB11184	20-140x	80	Porro	BAK-4	4.0	Multi-Coated	Center	54/18@20x	87/29	13.5	70.4
AB10594	25-125x	80	Porro	BAK-4	3.3	Multi-Coated	Center	54/18@25x	82/25	13.3	71.0
AB10592	20-100x	70	Porro	BAK-4	3.5	Multi-Coated	Center	66/22@20x	75/23	16.5	50.0
AB10172	12-60x	70	Porro	BK-7	5.8	Fully Coated	Center	120/40@12x	49/15	21.0	51.5
AB10762	10-30x	60	Porro	BK-7	6.0	Multi-Coated	Center	195/65@10x	32.8/10	13.0	41.6
CO11338	10-30x	60	Porro	BK-7	6	Fully-Coated	Center	189/63@10x	32.8/10	14	32
AB13372	10-30x	50	Reverse Porro	BK7	5-1.67	Fully-Coated	Center	192/64@10x	32.8/10	14.5-12.5	32
AB10168	10-30x	50	Porro	BK-7	5.0	Multi-Coated	Center	195/65@10x	26/8	15.0	31.75
AB11180	8-24x	50	Porro	BK-7	6.2	Multi-Coated	Center	225/75@8x	21.32/6.5	20	28
CO10686	7-21x	40	Reverse Porro	BK-7	5.5	Fully-Coated	Center	270/90@7x	32.8/10	14-12	26.46
AB12542	9-27x	25	Porro	BK-7	2.8	Fully-Coated	Center	230/70@9x	23/7	10	12.95

The binocular series for all reasons. The X-Trail series is made for the great outdoors. They are not only top performers and extremely rugged, but offer an amazing value for quality optics and durability. Select from a wide variety of sizes and styles including wide angle, full size, high-powered large porros and different magnifications. No matter what kind of outdoor activity you enjoy, you'll find an X-Trail model that's the perfect size and power.

X-Trail Features

A full line of porro prism binoculars with a variety of magnifications | Quality coated optics for outstanding performance | Wide angle models provides a wider field of view | Large objective lenses maximize light transmission for sharper images | Rugged and durable rubber armor with non-slip grip | Ideal for all outdoor activities and sporting events | Includes carrying case and neckstrap | Limited Lifetime Warranty

Wide-Angle (WA) Porro System

Models CO10672 and CO10676 feature wide angle Porro Prism binoculars.

Reverse Porro System

Models AB10176 and AB10174 have objectives are offset from the eyepiece in a horizontal way reducing the total size of the construction by about 30% compared to the traditional porro prism system.



30x80
AB10768
Braced-in tripod-mounting post, includes premium carrying case



20x80 WP
AB10590
Braced-in tripod-mounting post, includes premium carrying case



15x70
AB10154
Includes Tripod & Tripod Adapter



12x60
AB13648



20x50 Wide Angle
CO10676



10x50 Wide Angle
CO10673



10x50 Ruby Lens
Reverse Porro Prism
AB10176



8x42 Ruby Lens
Reverse Porro Prism
AB10174



8x30
AB13346

Model #	Magnification	Objective Lens (mm)	Prism Type	Prism Glass	Exit Pupil (mm)	Optical Coating	Focus System	Field of View (ft@1000yds/m@1000m)	Close Focus (ft/m)	Eye Relief (mm)	Weight (oz.)
AB10768	30x	80	Porro	BAK-4	2.67	Multi-Coated	Center	111/37	82/25	10.0	68.8
AB10590	20x	80	Porro	BAK-4	4.0	Multi-Coated	Center	189/63	72/22	15.4	80
AB10154	15x	70	Porro	BAK-4	4.7	Fully Coated	Center	231/77	49.2/15	20.0	44.8
AB13648	12x	60	Porro	BK-7	5	Multi-Coated	Center	246/82	33/10	11.8	36.8
CO10676	20x	50	Porro	BK-7	2.5	Fully-Coated	Center	168/56	29.52/9	7.2	29.45
CO10673	10x	50	Porro	BK-7	4	Fully-Coated	Center	367/122	19.6/6	12.7	28.21
AB10176	10x	50	Rev. Porro	BK-7	5.0	Multi-Coated	Center	324/108	33/10	20.0	29.98
AB10174	8x	42	Rev. Porro	BK-7	5.25	Multi-Coated	Center	378/126	33/10	20.0	26.46
AB13346	8x	30	Porro	BK7	3.7	Fully-Coated	Center	393/131	10/3	11.8	20.8

LUCID VIEW | Binoculars

The Lucid View series is the perfect blend of functionality and compact portability. This folding roof prism series offers a wide range of fully coated models from 8x to 20x. Armored with black or camouflage protective rubber, Lucid View is a great multi-purpose binocular for field use, sports, backpacking or camping. The smaller models will fit into the palm of your hand or slip into your pockets so you can always have them handy. Lucid View is small in size, but undeniably big on convenience.

Lucid View Features

Great style and value | Compact and lightweight | Fully coated optics for bright images | Protective rubber armor with firm grip design | Available in black and camo finish | Ideal for travel, concerts and sporting events | Includes carrying case and neckstrap | Limited Lifetime Warranty

10x42
AB13336



16x42 AB11366
10x42 AB11364



20x32 AB10670
16x32 Camo AB10123 Clam
16x32 AB10114
12x32 AB10113 Clam
AB10115 Clam



16x32 AB13345



12x25 Camo AB11361
12x25 AB10209 Clam
10x25 Camo AB10119 Clam
10x25 AB10110, AB10111 Clam



10x25 AB13275 Clam



8x21 AB13273 Clam



8x21 AB10108, AB10109 Clam



10x25 Camo AA10195 Clam

Model #	Magnification	Objective Lens (mm)	Prism Type	Prism Glass	Exit Pupil (mm)	Optical Coating	Focus System	Field of View (ft@1000yds/m@1000m)	Close Focus (ft/m)	Eye Relief (mm)	Weight (oz.)
AB11366	16x	42	Roof	BK-7	3.5	Fully Coated	Center	188/63	5.5/1.6	10	15
AB11364	10x	42	Roof	BK-7	4.2	Fully Coated	Center	262/87	5.5/1.6	12	15
AB13336	10x	42	Roof	BK-7	3.5	Fully Coated	Center	262/87	16/5	11.5	21.6
AB10670	20x	32	Roof	BK-7	1.6	Fully Coated	Center	147/49	26/8	10	10.93
AB13345	16x	32	Roof	BK-7	2.6	Fully Coated	Center	246/82	32/10	11	12
AB10114	16x	32	Roof	BK-7	2.0	Fully Coated	Center	188/63	21/7	10.5	10.93
AB10113	12x	32	Roof	BK-7	2.7	Fully Coated	Center	236/79	21/7	10.5	10.93
AB10209	12x	25	Roof	BK-7	2.1	Fully Coated	Center	240/80	21/7	10.5	10.14
AB13275	10x	25	Roof	BK-7	2.5	Fully Coated	Center	302/101	18/5.5	10.5	10.56
AB10110	10x	25	Roof	BK-7	2.5	Fully Coated	Center	302/101	20/6	10.5	10.14
AB10108	8x	21	Roof	BK-7	2.6	Fully Coated	Center	383/128	16/5	10.5	6.17
AB13273	8x	21	Roof	BK-7	2.63	Fully Coated	Center	383/128	16/5	10.5	7.2
AA10195	10x	25	Roof	BK-7	2.5	Fully Coated	Eyepiece	288/96	26/8	10.5	3.75

Barska's 25mm waterproof binoculars are a handy, waterproof optic that can be useful for a wide range of outdoor activities. The fixed magnification is ideal for mid-range bird watching, hiking, or sightseeing, and lightweight enough to hold steady. Fully coated optics transmit bright clear images throughout the entire focus range, and the rubber armored housing helps protect your optics from moisture and light shock. The ergonomic design and complementing features of this binocular delivers a comfortable user-experience and quality images. Backed by a Limited Lifetime Warranty.

Compact Waterproof Binocular

- Ideal for a wide range of outdoor activities in all weather conditions
- Shock absorbing rubber armor
- Waterproof and fogproof
- Compact and lightweight
- A variety of colors to choose from
- Includes neck strap and carrying case

10x25 WP
AB12418



10x25 WP
AB12725 Clam



10x25 WP
AB12726
AB12727 Clam



10x25 WP
AB12723 Clam



10x25 WP
CO10696
CO10697 Clam

12x25 WP
CO11010

Model #	Magnification	Objective Lens (mm)	Prism Type	Prism Glass	Exit Pupil (mm)	Optical Coating	Focus System	Field of View (ft@1000yds/m@1000m)	Close Focus (ft/m)	Eye Relief (mm)	Weight (oz.)
AB12418	10x	25	Roof	BK-7	2.5	Fully-Coated	Center	303/101	26.2/8	2.5	13.45
CO11010	12x	25	Roof	BK-7	2.08	Fully-Coated	Center	294/98	26.2/8	11	13.45

BLUELINE - COLORADO



BlueLine is a series of specialty items with unique and special features. There is something different for everyone, and makes the perfect gift for any occasion. Limited Lifetime Warranty.

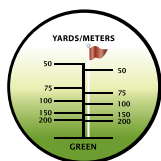

8x22 Golf Scope
AA10199

- Ruby coated optics
- 100% Water resistant
- Range: 50-200 yards
- Estimate the range to the pin with internal distance reticle
- Includes wrist strap and leatherette pouch



10x25
CO11370
CO11371 Clam

- Compact and lightweight
- Large center focus wheel
- Includes neck strap and carrying case



12x32
AB12510

- Textured rubber armor coating for a firm grip
- Ideal for general observation
- Includes carrying case and neckstrap



NEW
10x42 WP
AB13703

- Waterproof and fogproof
- Rubber armor coating for a firm grip
- Ideal for general observation
- Includes carrying case and neckstrap

Model #	Magnification	Objective Lens (mm)	Prism Type	Prism Glass	Exit Pupil (mm)	Optical Coating	Focus System	Field of View (ft@1000yds/m@1000m)	Close Focus (ft/m)	Eye Relief (mm)	Weight (oz.)
AA10199	8x	22	Roof	BK-7	2.75	Multi-Coated	Free	367/122	59/18	10.5	2.82
CO11370	10x	25	Porro	BK-7	2.5	Fully-Coated	Center	288/96	16.4/5	11	7.2
AB12510	12x	32	Roof	BK-7	2.7	Fully-Coated	Center	237/79	18.04/5.5	10.5	14.4
AB13703	10x	42	Roof	BK-7	4.2	Fully-Coated	Center	305/102	15/4.57	13.6	24

Night Vision | Binoculars

See clearly in complete darkness with these Night Vision Binoculars. The dual infrared illuminator allows viewing in daylight or in complete darkness. Ideal for a wide variety of nighttime uses such as surveillance, nighttime hunting and general nighttime observation. User-friendly design for easy viewing in dark environments. Backed by BARSKA's One Year Limited Warranty.

Night Vision NVX100 Monocular

BQ12388

Features

- 3x magnification
- Records images and video
- Large menu buttons
- Built-in tripod mount
- Day or night viewing
- Internal screen
- Illuminator allows viewing in the dark up to 328ft/100m
- Display images and videos on the television
- Easily transfer files to a computer
- Includes 4GB micro SD card, mini USB cable, AV cable, neckstrap and soft carrying case



Night Vision NVX300 Binoculars

BQ13374

Features

- 7x magnification
- Records images and video
- Day or night viewing
- 7 levels of IR brightness
- Illuminator allows viewing in the dark up to 328ft/100m
- Transfer image and video files to a computer
- Adjustable center focus
- Built-in tripod mount
- Includes USB cable and carry strap



Night Vision NVX600 Binocular

BQ13504

Features

- 7x magnification with 2x digital zoom
- Records images and video
- Day and night viewing
- Illuminator allows viewing in the dark up to 984ft/300m
- Transfer image and video files to a computer
- Adjustable focus
- Built-in tripod mount
- Includes AV cable and hard case



Night Vision NVX700 Monocular

BQ13506

Features

- 9x magnification with 2.6x digital zoom
- Records images and video
- Day and night viewing
- Illuminator allows viewing in the dark up to 656ft/200m
- Transfer image and video files to a computer
- Adjustable focus
- Built-in tripod mount
- Includes USB cable and soft carrying case

Model #	Resolution	Power	Exit Pupil (mm)	Field of View (ft@1000yds/m@1000m)	Min Focus Range (ft/m)	Lighting System Luminance	Lighting System IR Wavelength	Video Recording Format	AV Supporting	Weight (oz.)	Batteries Required
BQ12388	640 x 480	3x	20	328/100	.3 / 1	3W Infrared LED	850nm	H.264	NTSC/PAL	8.8	4x AA
BQ13374	640 x 480	7x	20	328/100	.3 / 1	1.5W Infrared LED	850nm	na	na	15.2	4x AA
BQ13504	640 x 480	7x	30	984/300	1m	3W	850nm	VGA	NTSC/PAL	17.6	4x AA
BQ13506	640 x 480	9x	15	656/200	1m	3W	850nm	VGA	NTSC/PAL	10.4	4x AA

BARSKA's Encounter series of "Jumbo" observation binoculars are incomparable optical instruments that are perfect for long range terrestrial viewing and celestial viewing. Jumbo observation binoculars are the preferred alternative to decorative telescopes that may not be optically suitable for the demands of terrestrial viewing or an expensive astronomical telescope that may be complicated to use and have less optical quality and design integrity than a Jumbo. These solidly-engineered binoculars

feature rigid all metal construction, large objective lenses for maximum light gathering and precision eyepieces with individual focus. When not in use, the Encounter Jumbo can be stored in the included deluxe rigid foam lined carrying case. No matter which model you select, rest assured that you are investing in a fine piece of optical equipment that you and your family can enjoy for years to come.



U Mount Tripod (for AB10520)
AF13480

- Specifically designed with model AB10520
- U mount is made from aluminum alloy material
- Tripod is made from stainless steel material
- Extendable locking leg
- Min. height: 36 inches
- Max. height: 54.5 inches
- Binocular sold separately



20x,40x100 WP Jumbo Binoculars

AB10520

- Waterproof construction with a rigid all-metal body
- Dual power interchangeable 20x and 40x eyepieces
- Multi-coated optics maximizes light transmission, enhancing clarity
- Large semi-apochromatic 100mm objective lens
- High quality BAK-4 prisms
- Performs well in low-light conditions
- Ideal for celestial and terrestrial observation
- Packaged in premium hard case
- Tripod and mount sold separately
- One-Year Limited Warranty



16x70 Jumbo Binoculars

AB12766

- All metal construction
- Large 70mm objective lenses for maximum light gathering
- Porro prism optical design
- Precision eyepieces with individual focus
- High quality BAK-4 prisms
- Fully multi-coated optics for maximum image clarity
- Convenient removable carrying handle
- Tripod adaptable
- Includes deluxe rigid foam-lined storage case
- One-Year Limited Warranty



Model #	Magnifi.	Objective Lens (mm)	Prism Type	Prism Glass	Exit Pupil (mm)	Optical Coating	Focus System	Field of View (ft@1000yds/m@1000m)	Close Focus (ft/m)	Eye Relief (mm)	Weight (lbs.)
AB10520	20x, 40x	100	Porro	BAK-4	5@20x, 2.5@40x	Multi	Individual	131/43.8@20x 63.9/21.3@40x	65.6/20	23.6@20x, 18.4@40x	16.93
AB12766	16x	70	Porro	BAK-4	4.4@16x	Fully Multi	Individual	147/54.51	82/25	22	8.6



Digital Tripod

AF12440

Compact tripod ideal for small optical devices, such as a digital camera, video camera, or almost any other lightweight item that is tripod adaptable

- Pan head tripod standard platform
- Compact and lightweight
- Extendable legs
- Carrying case included
- Max. load weight 5.5 lbs
- Min. height: 14 inches
- Max. height: 40 inches



Elite Tripod

AF12472

Tripod features an accessory hook that can be used to further stabilize the tripod in very windy conditions. Hang a counter weight (not supplied) onto the hook to stabilize your tripod. Extendable locking legs with rubber feet for stability.

- Quick release platform
- Extendable legs
- Rubber feet
- Accessory hook
- Carrying case included
- Max. load weight 8.82 lbs
- Min. height: 18 inches
- Max. height: 53 inches



Professional Tripod

AF13650

Lightweight tripod that features a bubble level, panning handle and tilt handle to make precise adjustments. Features extendable locking legs with rubber feet for stability.

- Quick release platform
- Extendable legs
- Rubber feet
- Levelling bubble
- Carrying case included
- Max. load weight 6.75 lbs
- Min. height: 24 inches
- Max. height: 67 inches



Deluxe Tripod

AF10374

Tripod features an accessory hook that can be used to further stabilize the tripod in very windy conditions. Hang a counter weight (not supplied) onto the hook to stabilize your tripod.

- Quick release platform
- Accessory hook
- Extendable legs
- Carrying case included
- Max. load weight 8.82 lbs
- Min. height : 26.6 inches
- Max. height: 63.4 inches



TRIPODS

Heavy Duty Table Top Tripod

AF13270

Provides steady viewing in a compact and portable design. Pan head tripod is perfect for stabilizing cameras, binoculars, video cameras, spotting scopes, and much more. Can easily be transported in a backpack or small bag and is strong enough to support a large DSLR camera or high-powered spotting scope.

- No-slip rubber feet
- Pan head handle
- Min. height: 11.5 inches
- Max. height: 14 inches

**Metal Table Top Tripod**

AF12652

Provides a steady viewing in a compact and portable design. Attaches to most cameras, binoculars, video cameras, spotting scopes and much more. Secure your viewing position by turning the adjustment lever and locking the viewing angle into place. This lightweight tripod can easily be transported in a backpack or small bag and is strong enough to support a large DSLR Camera or high-powered Spotting Scope.

- No-slip rubber feet
- Pan head handle
- Legs of tripod 10 inches
- Height of tripod 9.5 inches

**Monopod**

AF12548

Sturdy, lightweight aluminum camera support that helps you to capture clear, crisp images when you don't want carry a tripod around with you. Easily mount a compact camera, DSLR, compact camcorder, or even binoculars for solid support.

- Sturdy, lightweight aluminum
- Extendable locking leg
- Spiked foot
- Rubberized grip
- Carrying case and wrist strap included
- Min. height: 21 inches
- Max. height: 67 inches

**Ball Joint Tripod Head**

AF12544

- Easily attaches to most tripods
- Supports lightweight to medium SLR systems
- Ball-and-socket head design allows for quick camera positioning at virtually any angle
- Features a vertical cut out for viewing straight down
- Quick-release mounting platform
- Adjustable locking levers
- All-metal construction



TRIPOD ACCESSORIES

DIGISCOPING ADAPTORS

Take your nature viewing to the next level and start “digiscoping”! BARSKA's versatile Digital Camera Adapter is a universal mounting platform that allows you to do “afocal” photography (photography through the eyepiece of a spotting scope) using your digital camera or video recorder. The digital camera adapter features an adjustable

device mount that attaches to a tripod and a separately adjustable camera mount that is made to accommodate different camera models and zoom capabilities. BARSKA's Digital Camera Adapter is a durable, easy to use and convenient addition to your outdoor gear.

Camera to Spotting Scope Adaptor

AF11286

Mounting ring adjusts for lens sizes from 38.1mm to 66.7mm. Connect your camera to your spotting scope with this adaptor to take high magnification images. The camera to spotting scope adaptor is a universal mounting camera to spotting scope mounting adaptor. The extendable telescoping arm allows you to mount small to large cameras to a spotting scopes eyepiece. Specifications: Will fit cameras up to 200mm in length. From mounting foot connection to cameras objective lens 200mm and hold up to 3lbs.

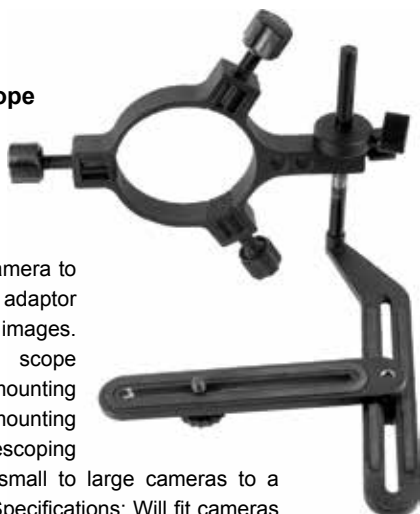

Digiscoping Adaptor

AF10540

Digiscoping Adaptor is a nifty instrument that holds a digital camera to the eyepiece of a spotting scope, astronomical telescope or monocular to capture images viewed. Adapt to digitally capture images of terrestrial and celestial objects! Fits cameras with eyepieces having an outside diameter of 28mm to 45mm.



Binocular Tripod Adaptor

AF10546

- Solid and sturdy
- Fits most binoculars equipped with adaptor screws
- To be used with tripods or window mounts



Binocular Harness

AF13250

- Harness distributes the weight of the binoculars on the shoulders not the neck
- Made from comfortable nylon/lycra straps
- Easy to attach and adjustable



Accu-Grip Handheld Tripod

AF10926

- For convenient handheld stable viewing
- Can be used with spotting scopes, binoculars and cameras that are tripod adaptable
- Can be added to a tripod for an extension and grip



Car Window Mount

AF10544

- A perfect mount for your spotting scopes or binoculars
- Ideal for observation from the comfort of your car

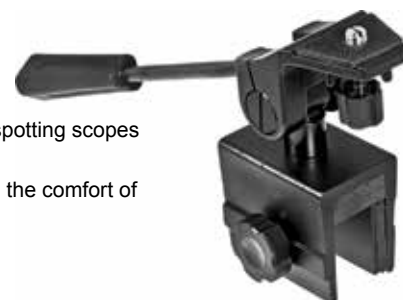



BARSKA® SPOTTING SCOPES

BARSKA Spotting Scopes

A spotting scope is an indispensable part of the hunter, target shooter, birder or outdoor naturalist's gear. No one offers the selection of styles and sizes of spotting scopes like BARSKA. Our Naturescape spotters are in a class of their own. Combines high quality fully multi-coated optics and wide zoom range in a sleek "go-anywhere" compact body. Whatever BARSKA spotting scope model you select, you can be sure that it will provide you with dependability and countless years of enjoyable viewing.

SPOTTING SCOPE TERMINOLOGY

A spotting scope is an optical instrument that is used for spotting or viewing distant objects such as wildlife or landmarks. It is usually high powered but compact.

PRISM SYSTEM/TYPE

The prism system of a spotting scope reduces the size of a long optical path and correct an inverted image.

Roof Prism System

The prisms overlap and are aligned in a straight line with the lenses allowing to have a slim construction.

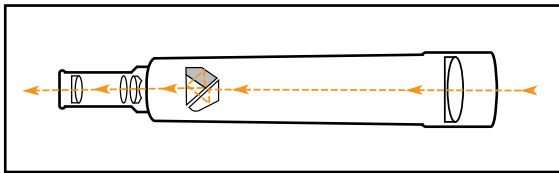

Porro Prism System

The objective is offset from the eyepiece offering greater depth perception and a wider field of view.

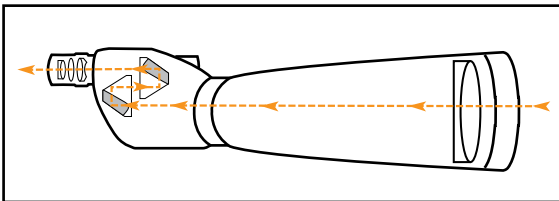

PRISM GLASS

The common standards of optical prisms are barium-crown (BAK-4) glass or borosilicate (BK-7) glass. The BAK-4 is a higher quality glass that reduces light scattering, resulting in sharper and brighter images.

OBJECTIVE LENS DIAMETER

The second number in the reference (i.e. 20-60x60) indicates the diameter of the objective lens or the front lens. The larger the objective lens, the better the light transmission, thus the brighter the image.

ED (Extra Low Dispersion) Glass

ED Glass is designed to provide precise optical color correction. It is multi-coated to improve contrast and transmission across the visual spectrum and provides reduced chromatic aberration.

MAGNIFICATION (POWER)

Magnification is the number of times the object being viewed is enlarged. The spotting scope is often identified by two numbers, for example: 20-60x60. The first number (i.e., 20-60x60) indicates the magnification or the power of the scope, expressed by the letter "x", for times. With this variable zoom power, that means that the object being viewed appears to be 20 to 60 times closer than would be seen with the naked eye.

OPTICAL COATINGS

Various coating processes on the lenses and prisms will determine the brightness and the light gathering of a spotting scope, providing higher contrast and brighter images. The types of coating are:

Coated - A single layer on at least one lens surface.

Fully Coated - A single layer on all air-to-glass lens surfaces

Multi-Coated - Multiple layers on at least one lens surface.

Fully Multi-Coated - Multiple layers on all air-to-glass surfaces.



FOCUS SYSTEM

The mechanism, usually with a turn-adjustable knob, that is used to focus the spotting scope on the object being viewed.

FIELD OF VIEW (F.O.V.)

This is the side-to-side linear measurement of the circular field seen through a spotting scope. It is defined by the width in feet of the area visible at 1000 yards, or in meters at 1000m. The higher the magnification, the narrower the field of view.

CLOSE FOCUS DISTANCE

The closest distance to the observed object that the spotting scope can be used while retaining a sharp focus.

RESOLUTION

The measurement of the scope's ability to distinguish fine detail and sharpness.

EXIT PUPIL

This refers to the size of the small disc of light that exits a spotting scope. To determine the size, divide the objective lens diameter by the power. For example a 20x60 spotting scope will have an exit pupil of 3mm. ($60/20=3$)

EYE RELIEF

This is the distance a scope can be held away from the human eye and can still observe the entire field of view. Long Eye Relief (LER) reduces eyestrain and is more comfortable for eyeglass wearers.

WATERPROOF/FOGPROOF

Spotting scopes can be O-ring sealed for waterproof protection, and fogproof which means that they are nitrogen-purged to prevent anti-fogging inside the optical surfaces. These models are able to keep completely dry inside after immersion in water.

SPOTTING SCOPE LIMITED LIFETIME WARRANTY

(Within USA and Canada only)

This warranty does not cover consumer-caused damages, abuse, normal wear-and-tear, unauthorized repairs or modifications. For further detailed information, please refer to the warranty policy enclosed with products.

LEVEL ED™

Extra Low Dispersion Glass | Triplet Apochromatic Lens | Waterproof



20-60x85 WP, Angled
AD12806

The Level ED Spotting Scope is in a class of its own, combining optical superiority with rugged durability. Fitted with Extra Low Dispersion (ED) glass and a Triplet Apochromatic lens, the Level ED spotter delivers crystal-clear images with enhanced color, contrast, and light transmission. The powerful 20-60x zoom magnification range is perfect for both wide landscape observation and detailed close-up viewing, while the large 85mm objective lens helps maximize light transmission in low lighting situations. The Level ED APO Spotter features an extendable sunshade and comes complete with a protective soft case.

Level ED Features

Extra Low Dispersion (ED) glass enhances image resolution, color, and contrast | Triplet Apochromatic Lens reduces chromatic aberration | Fully-multi coated optics maximizes light transmission for superior brightness and clarity | Large objective lens increases light gathering ability thus delivering brighter images in low-light conditions | Waterproof and fogproof | Coarse and fine focus adjustments | Angled eyepiece | Glare-reducing sunshade | Ideal for all-weather conditions | Includes soft carrying case | Limited Lifetime Warranty

Model #	Magnifi.	Objective Lens	Prism Type	Eyepiece System	Optical Coating	Field of View (ft@1000yds/m@1000m)	Close Focus (ft/m)	Exit Pupil (mm)	Eye Relief (mm)	Weight (lbs)	Length (inch)	Tripod
AD12806	20-60x	85mm	Porro	Angled	Fully Multi	114ft/34.74@20x, 60ft/18.2@60x	16.4/4.5	4.25@20x, 1.42@60x	20@20x	4.9	16.5	No

Level spotters set the standard for portability, optical performance and value. At home in the wild or at the target range, Level spotter's fully multi-coated optics and large objective lens delivers crisp clear views. Variable zoom magnifications allow you to lock on to your subject then zoom in for greater detail. All Level spotter are waterproof as well as fogproof. Glare-reducing extendable sunshade. Which ever Level spotter you choose you can rely on quality and performance that will enhance almost any viewing experience. Includes hard and soft carrying cases and tripod and carrying case. Backed by BARSKA's Limited Lifetime Warranty.



20-60x65 WP
AD12354

Includes: Hard and soft carrying cases and pan head lever tripod



20-60x65 WP, Angled
AD12356

Includes: Hard and soft carrying cases and pan head lever tripod



20-60x65 WP Mossy Oak®, Break-Up®
AD12358

Includes: Hard and soft carrying cases and pan head lever tripod



20-60x80 WP, Angled
AD12360

Includes: Hard and soft carrying cases and pan head lever tripod



Actual soft carrying case may vary

Level Features

A wide variety of styles to choose from with variable zoom magnifications for different applications | Fully-multi coated optics maximizes light transmission for superior brightness and clarity | Large objective lens increases light gathering ability thus delivering brighter images in low-light conditions | Waterproof and fogproof protection | Textured rubber body for a firm grip | Glare-reducing sunshade | Ideal for a wide range of outdoor activities | Includes hard and soft carrying cases and pan head lever tripod | Limited Lifetime Warranty

Model #	Magnifi.	Objective Lens	Prism Type	Eyepiece System	Optical Coating	Field of View (ft@1000yds/m@1000m)	Close Focus (ft/m)	Exit Pupil (mm)	Eye Relief (mm)	Weight (lbs)	Length (inch)	Tripod
AD12360	20-60x	80mm	Porro	Angled	Fully-Multi	81.37/27.13@20x, 52.5/17.5@60x	29.52/9	3.8@20x, 1.36@60x	17@20x, 14.2@60x	3.3	13.5	Pan-head
AD12354	20-60x	65mm	Porro	Straight	Fully-Multi	72.45/24.15@20x, 30.45/10.15@60x	29.52/9	3.1@20x, 1.1@60x	17@20x, 15@60x	2.45	17	Pan-head
AD12356	20-60x	65mm	Porro	Angled	Fully-Multi	72.45/24.15@20x, 30.45/10.15@60x	29.52/9	3.1@20x, 1.1@60x	17@20x, 15@60x	2.45	15.75	Pan-head
AD12358	20-60x	65mm	Porro	Straight	Fully-Multi	72.45/24.15@20x, 30.45/10.15@60x	29.52/9	3.1@20x, 1.1@60x	17@20x, 15@60x	2.45	14.25	Pan-head



BARSKA's Naturescape ED Series models take spotting scope optics to a higher level. BAK-4 prisms and fully multi-coated premium ED (Extra Low Dispersion) glass provide you with views of exceptional clarity and resolution. Compared to conventional achromatic lenses, ED glass lenses minimize chromatic aberration and other forms of distortion resulting in higher resolution and contrast. Waterproof and fogproof, Naturescape ED spotters are at home in the most demanding environments and are ruggedly built to withstand the effects of movement from one location to another. Naturescape ED spotters include a deluxe hard carrying case and BARSKA's Limited Lifetime Warranty.

Naturescape ED Features

ED (Extra Low Dispersion) glass | Fully multi-coated optics | Zoom magnification | BAK-4 prisms | Twist-up eyepiece | Waterproof and fogproof | Built-in glare reducing extendable sunshade | Limited Lifetime Warranty



15-45x65 ED WP

- AD11108
- ED (Extra Low Dispersion) glass
- Fully multi-coated optics
- Includes Protective hard carrying case



65mm model includes:
Deluxe hard carrying case



12-36x50 ED WP

- AD11104
- ED (Extra Low Dispersion) glass
- Fully multi-coated optics
- Includes tripod and protective hard carrying case



50mm & 60mm models includes:
Pan head tripod and deluxe hard and soft carrying cases

Model #	Magnifi.	Objective Lens	Prism Type	Eyepiece System	Optical Coating	Field of View (ft@1000yds/m@1000m)	Close Focus (ft/m)	Exit Pupil (mm)	Eye Relief (mm)	Weight (lbs)	Length (inch)	Tripod
AD11108	15-45x	65	Porro	Straight	Fully Multi	138/46@15x 64/21@45x	19.68/6	4.2@15x, 1.4@45x	20@15x, 18@45x	3.08	15.54	No
AD11104	12-36x	50	Porro	Straight	Fully Multi	180/60@12x, 90/30@36x	9.84/3	4.2@12x, 1.4@36x	19@12x, 17@36x	1.98	14.52	Pan Head



20-60x60 WP, Angled
AD12684



15-45x50 WP, Angled
AD12682

The Naturescape Series offers outstanding brightness and clarity for an unrivaled viewing experience. Variable zoom magnification allows you to lock onto your subject and then zoom in for greater detail. A perfect blend of rugged durability with exceptional fully multi-coated lenses, making these spotters perfect for birders, hunters, and naturalists. Includes pan-head tripod and a soft carrying case.

Naturescape Features

Fully multi-coated optics maximizes light transmission for superior brightness and clarity | Large objective lens for increased light gathering ability | O-ring sealed for waterproof protection | Convenient and portable | Includes pan-head tripod and soft case | Limited Lifetime Warranty

Model #	Magnifi.	Objective Lens	Prism Type	Eyepiece System	Optical Coating	Field of View (ft@1000yds/m@1000m)	Close Focus (ft/m)	Exit Pupil (mm)	Eye Relief (mm)	Weight (lbs)	Length (inch)	Tripod
AD12684	20-60x	60	Porro	Angled	Fully Multi	120/36.57@20x, 57.6/17.55@60x	15/5	3@20x, 1@60x	17@20x, 14@60x	1.9	13.4	Table Top
AD12682	15-45x	50	Porro	Angled	Fully Multi	137/45.6@15x, 66/22@45x	12/4	4@15x, 1.33@45x	17@15x, 14@45x	1.5	11	Table Top



BENCHMARK DFS | Spotting Scope

Benchmark spotting scopes are designed to provide an extreme and comprehensive level of spotting pleasure to both shooters and all types of nature explorers. Engineered with innovative Dynamic Focusing System, focus by turning the objective lens you will appreciate Benchmark's stunning performance and ruggedness. They set the standards for portability and ease of use.

Benchmark DFS Features

Nitrogen-purged and sealed to prevent fogging and internal corrosion | O-ring sealed for waterproof protection | Adjustable zoom power eyepiece allows you to increase magnification to get a closer look | Includes compact pan head tripod, ACCU-grip handheld mount and protective case | Limited Lifetime Warranty



25-125x88 WP
AD11182

Includes: Soft carrying case, premium hard case, panhead lever tripod and Accu-grip handheld tripod



18-90x88 WP
AD11334

Includes: Soft carrying case, premium hard case, panhead lever tripod and Accu-grip handheld tripod



8-24x58 WP
AD10786

Includes: Premium Soft case, panhead lever tripod and Accu-grip handheld tripod

Model #	Magnifi.	Objective Lens	Prism Type	Eyepiece System	Optical Coating	Field of View (ft@1000yds/m@1000m)	Close Focus (ft/m)	Exit Pupil (mm)	Eye Relief (mm)	Weight (lbs)	Length (inch)	Tripod
AD11182	25-125x	88mm	Porro	Straight	Fully	54/18@25, 24/8@125x	18/6	3.2@25x, 0.64@125x	13.3@25x, 7.6@125x	1.78	13.2	Pan-head
AD11334	18-90x	88mm	Porro	Straight	Fully	120.9/40.3@18x · 44.3/14.8@90x	32.8/10	6.15@18x-1.2@90x	19@18x, 13@90x	1.78	13.2	Pan-head
AD10786	8-24x	58mm	Porro	Straight	Fully	225/75@8x, 116/39@24x	10.8/3.3	5.6@8x, 1.8@24x	19@8x, 14.5@24x	1.54	7.8	Pan-head

BLACKHAWK ED | Waterproof Spotting Scopes



20-60x60 WP
AD11918

Includes: Soft case, premium hard case and pan head lever tripod



20-60x60 WP, Angled
AD11520

Includes: Soft case, premium hard case and pan head lever tripod

Performance that soars beyond your expectations! The Blackhawk ED Spotting Scope Series sets the standard for portability, optical performance, and value. At home at the target range or in the wild, these spotter are fully multi-coated optics and large objective lens delivers amazing clarity for the perfect viewing experience. Variable zoom magnifications allow you to lock on to your subject then zoom in for a more detailed look. Extra low dispersion (ED) glass can gather light needed for viewing in low-light conditions like dusk or dawn, and for observing the night sky. Waterproof and fogproof protection, and are coated in a protective rubber armor to safeguard it against impact. Includes a compact tripod, hard case, and soft carrying case and is backed by Barska's Limited Lifetime Warranty.

Blackhawk ED Features

Zoom magnifications for different applications | Fully multi coated optics maximizes light transmission for superior brightness and clarity | Extra low dispersion (ED) glass | Large objective lens increases light gathering ability thus delivering brighter images in low-light conditions | Waterproof and fogproof protection | Rubber armor designed to protect & absorb shock | Glare-reducing sunshade | Ideal for a wide range of outdoor activities | Limited Lifetime Warranty



Model #	Magnifi.	Objective Lens	Prism Type	Eyepiece System	Optical Coating	Field of View (ft@1000yds/m@1000m)	Close Focus (ft/m)	Exit Pupil (mm)	Eye Relief (mm)	Weight (lbs)	Length (inch)	Tripod
AD11918	20-60x	60mm	Porro	Straight	Fully-Multi	91/30@20x, 45/15@60x	15/4.7	3@20x, 1@60x	15.4@20x, 16.5@60x	2.86	14.96	Pan-head
AD11520	20-60x	60mm	Porro	Angled	Fully-Multi	91/30@20x, 45/15@60x	15/4.7	3@20x, 1@60x	15.4@20x, 16.5@60x	2.86	14.96	Pan-head

BLACKHAWK | Spotting Scopes

Blackhawk spotters set the standard for portability, optical performance and value. At home at the target range or in the wild, Blackhawk spotter's coated optics and large objective lens delivers crisp clear views. Variable zoom magnifications allow you to lock on to your subject then zoom in for greater detail. Selected models are waterproof as well as fogproof. Thoughtful features like a glare-reducing sunshade and sight tube are also available on selected models. No matter which Blackhawk spotter you choose you can rely on quality and performance that will enhance your viewing experiences. Most models include tripod and carrying case. Blackhawk spotters are backed by BARSKA'S Limited Lifetime Warranty.

Blackhawk Features

A wide variety of models with variable zoom magnifications for different applications | Coated optics maximizes light transmission for superior brightness and clarity | Massive objective lens increases light gathering ability thus delivering brighter images in low-light conditions | Waterproof and fogproof protection | Rubber armor designed to protect & absorb shock | Glare-reducing sunshade | Sight tube for quick targeting (larger models) | Convenient and portable | Ergonomically designed to enhance overall handling | Ideal for all-weather conditions | Limited Lifetime Warranty



18-36x50 WP
AD11114

Includes: Soft carrying case, and pan head lever tripod

18-36x50 WP, Angled
AD10348

Includes: Soft carrying case, and pan head lever tripod

Model #	Magnifi.	Objective Lens	Prism Type	Eyepiece System	Optical Coating	Field of View (ft@1000yds/m@1000m)	Close Focus (ft/m)	Exit Pupil (mm)	Eye Relief (mm)	Weight (lbs)	Length (inch)	Tripod
AD11114	18-36x	50mm	Porro	Straight	Multi	137/45@18x, 100/33@36x	23/7	2.8@18x, 1.4@36x	20@18x, 17@36x	3.3	12	Pan-head



20-60x60 WP
Mossy Oak®, Break-Up®
 AD10976

Includes: Soft carrying case, premium hard case and pan head lever tripod
 Blend-in with **Mossy Oak®, Break-Up®** Camouflage on Barska's Blackhawk hunting spotting scope.

20-60x60 WP
 AD10350
Includes: Soft carrying case, premium hard case and pan head lever tripod

20-60x60 WP, Angled
 AD11284
Includes: Soft case, premium hard case and pan head lever tripod



20-60x70 WP
 AD10528
Includes: Soft case, premium hard case and pan head lever tripod



20-60x60 WP, Angled
 AD12706
Includes: Soft case, premium hard case and pan head lever tripod



20-60x80 WP, Angled
 AD12162
Includes: Soft case, premium hard case and micro-adjustable tripod



25-75x100 WP, Angled
 AD12164
Includes: Soft case, premium hard case and micro-adjustable tripod

Model #	Magnifi.	Objective Lens	Prism Type	Eye-piece System	Optical Coating	Field of View (ft@1000yds/m@1000m)	Close Focus (ft/m)	Exit Pupil (mm)	Eye Relief (mm)	Weight (lbs)	Length (inch)	Tripod
AD10528	20-60x	70mm	Porro	Straight	Multi	93/32.0@20x, 52.5/17.5@60x	32.8/10	3.3@20x, 1.4@60x	14.4@20x, 11.2@60x	2.5	16.3	Pan-head
AD10976	20-60x	60mm	Porro	Straight	Multi	91/30@20x, 45/15@60x	23/7	3@20x, 1@60x	18@20x, 15@60x	2.86	14.96	Pan-head
AD12164	25-75x	100mm	Porro	Angled	Multi	88/29@25x, 44/15@75x	33/10	4.2@25x, 1.4@75x	17.5@25x, 16.5@75x	4.75	18	Micro-adj.
AD12162	20-60x	80mm	Porro	Angled	Multi	102/34@20x, 51/17@60x	33/10	3.09@20x, 1.3@60x	17.5@20x, 16.5@60x	3.5	16.5	Micro-adj.
AD12706	20-60x	60mm	Porro	Angled	Fully Multi	101/30.78@20x, 52/15.8@60x	26/8	3@20x, 1@60x	21@20x	2.05	13.25	Pan-head

SPOTTER PRO | Spotting Scopes



20-60x60 WP, Angled

AD12570

Includes table top tripod and protective carrying case

The right balance. Perfect for birders, hunters and naturalists, Spotter Pro delivers astounding brightness and clarity for optimal viewing. Variable zoom magnifications allow you to lock on to your subject then zoom in for greater detail. The Spotter Pro features waterproof and fogproof protection, making this scope adaptable to a wide range of outdoor activities. An unrivaled blend of ruggedness, waterproof integrity, durability and exceptional coated optics, Spotter Pro balances pure performance with value.

Spotter Pro Features

High variable zoom power for different magnifications | Premium coated optics for crisp and clear images | Large objective lens maximizes light transmission | O-ring sealed for waterproof protection | Extra long eye relief | Built-in extensible sunshade | Smooth rubberized finish for shock-protection | Maximum functionality in all weather-conditions | Compact and portable | Includes precision tripod and soft protective carrying case | Limited Lifetime Warranty

Model #	Magnifi.	Objective Lens	Prism Type	Eyepiece System	Optical Coating	Field of View (ft@1000yds/m@1000m)	Close Focus (ft/m)	Exit Pupil (mm)	Eye Relief (mm)	Weight (lbs)	Length (inch)	Tripod
AD12570	20-60x	60mm	Porro	Angled	Fully-Multi	94.5ft / 31.5m @ 20x, 52.5 ft / 17.6m @60x	36/11	3.3@20x,1.1@60x	32@20x,18@60x	1.65	12	Table Top

Ideal in both tactical and hunting environments. Both models are fully multi-coated BK-7 optics provide sharp bright viewing at any magnification in any conditions. Waterproof, fogproof and fully rubber armored, both compact scopes are extremely lightweight and easy to transport and use either hand-held or on its included mini tripod. Side focus knob for convenience and changing the eyepiece magnification is smooth and precise using the ribbed rubber focus ring.

Tactical Features

50mm Objective lens | Rubber armor for absorbing shock | Fully multi-coated | BK-7 prisms | Angled eyepiece | Attached lens cover | O-ring sealed for waterproof and fogproof protection | Includes soft carrying case and tripod | Limited Lifetime Warranty



11-44x50 WP, Angled
AD11112
· Side Focusing
· Includes Tripod and Case

11-33x50 WP, Angled
AD11430
· Side Focusing
· Mil-Cross Reticle
· Includes Tripod and Case

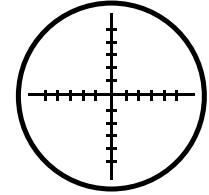

Mil-Cross Reticle



Model #	Magnifi.	Objective Lens	Prism Type	Eyepiece System	Optical Coating	Field of View (ft@1000yds/m@1000m)	Close Focus (ft/m)	Exit Pupil (mm)	Eye Relief (mm)	Weight (lbs)	Length (inch)	Tripod
AD11112	11-44x	50mm	Porro	Angled	Fully Multi	181/60@11x, 70/23@44x	13.12/4	4.5@11x, 1.1@44x	15.1@11x, 10.9@44x	1.4	11	Pan-head
AD11430	11-33x	50mm	Porro	Angled	Fully Multi	191/64@11x-89/30@33x	16.4/5	4.5@11x/1.5@33x	19.13-17.66	1.4	11	Pan-head

Big news! With crystal clear clarity and extreme ruggedness, nothing rivals the impact of Gladiator's unparalleled performance. Thanks to large objective lens sizes and Gladiator's superior coated optical systems, these scopes reveal every detail in optimum contrast, vivid color and sharp resolution. Waterproof and housed in a rubber armor covering to protect them from harsh weather conditions, these scopes are ideal for long-range big game stalking. Includes table top tripod or mount the scope to a photo tripod.

Gladiator Features

Waterproof and fogproof | Multi-coated optics maximizes light transmission | Massive objective lens increases light gathering ability thus delivering brighter images in low-light conditions | Built-in extendable sunshade | Rubber armor for absorbing shock | Ergonomically designed to enhance overall handling | Maximum functionality in all weather-conditions | Compatible with standard tripods | Includes soft carrying case and tripod | Limited Lifetime Warranty



20-60x90 WP
AD10606
· Includes Tripod & Soft Carrying Case

30-90x100 WP
AD11344
· Includes Tripod & Soft Carrying Case



Model #	Magnifi.	Objective Lens	Prism Type	Eyepiece System	Optical Coating	Field of View (ft@1000yds/m@1000m)	Close Focus (ft/m)	Exit Pupil (mm)	Eye Relief (mm)	Weight (lbs)	Length (inch)	Tripod
AD11344	30-90x	100mm	Porro	Straight	Multi	72/24@30x-35/11.67@90x	32.8/10	3.6@30x/1.2@90x	17.6@30x, 13.8@90x	6.3	18.9	Micro-Adj.
AD10606	20-60x	90mm	Porro	Straight	Multi	99.5/33.2@20x, 52.5/17.5@60x	32.8/10	5.1@20x, 1.7@60x	21.6@20x, 18.7@60x	3	16.7	Micro-Adj.



25-75x75, Angled

CO13304

- Includes Tripod & Soft Carrying Case



20-60x60, Angled

CO13302

- Includes Tripod & Soft Carrying Case



Perfect for birders, hunters and naturalists, this spotter delivers astounding brightness and clarity for optimal viewing. Colorado spotter's fully coated optics and large objective lenses delivers crisp clear views. Variable zoom magnifications allow you to lock on to your subject then zoom in for greater detail. Includes hard and soft carrying cases and tripod and carrying case. Backed by BARSKA's Limited Lifetime Warranty.

Colorado Features

Variable zoom magnifications for different applications | Fully coated optics maximizes light transmission for superior brightness and clarity | Large objective lens increases light gathering ability thus delivering brighter images in low-light conditions | Textured rubber body for a firm grip | Glare-reducing sunshade | Includes soft carrying case and pan head lever tripod | Limited Lifetime Warranty

Model #	Magnifi.	Objective Lens	Prism Type	Eye-piece System	Optical Coating	Field of View (ft@1000yds/m@1000m)	Close Focus (ft/m)	Exit Pupil (mm)	Eye Relief (mm)	Weight (lbs)	Length (inch)	Tripod
CO13304	25-75x	75mm	Roof	Angled	Fully	92/30@25x, 42/14@75x	32/10	3@25x	13@25x	2.75	16.25	Pan-head
CO13302	20-60x	60mm	Roof	Angled	Fully	116/53@20x	32/10	3@20x	13@20x	2.20	12.75	Pan-head

TELESCOPE TERMINOLOGY

A telescope is an optical instrument that is used to observe distant objects in the night sky. There are many styles and sizes of telescopes. Selecting a size and style depends on the type of observing you intend to do.

TYPES OF TELESCOPES

Refractors

Refractors are also known as “dioptrics”. Refractors are characterized by a long narrow optical tube. The diameter of the optical tube (usually denoted in millimeters) varies with the size of the objective (front) lens size. Light passes in a straight line from the front objective lens to a diagonal mirror located in the rear of the optical tube and directly to the eyepiece. Refractor telescopes are suitable for both celestial (night sky) and terrestrial (land) viewing. Note: Objects viewed through a refractor appear wrong reading left to right but right reading up and down.



Newtonian Reflectors

Newtonian Reflectors are also known as “catoptrics”. They use a concave parabolic primary mirror which collects and focuses incoming light onto a flat secondary (diagonal) mirror. The secondary mirror then reflects the image out of an opening at the side of the main optical tube and into the eyepiece. Reflector telescopes are most suitable for celestial (night sky) viewing. Note: Objects viewed through a reflector appear vertically inverted.

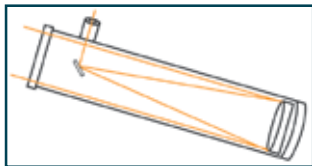

TELESCOPE MOUNTS

Altazimuth

The altazimuth (AltAz) is the simplest type of mount. It has two motions – up and down (altitude) and side-to-side/horizontal (azimuth). Better quality altazimuth mounts will have slow-motion knobs for making precise adjustments and aid in keeping tracking motion smooth. Altazimuth mounts are good for terrestrial (land) viewing and for scanning the night sky at lower power. They are not recommended for deep sky photography.



Altazimuth

Equatorial

Equatorial mounts are superior to non-computerized altazimuth mounts for astronomical observing over long periods of time. As the earth rotates around its axis, the stationary stars appear to move across the sky. A telescope on an equatorial mount can be aimed at a celestial object and easily guided using the manual slow-motion controls to follow the object across the sky and keep it in the view of the telescope. The equatorial mount is rotated on one axis (polar/right ascension) adjusted to your latitude and that axis is aligned to make it parallel to the Earth's axis, so that if that axis is



Equatorial

turned at the same rate of speed as the Earth, but in the opposite direction, objects will appear to sit still when viewed through the telescope. Equatorial mounts are preferable for deep sky observing.

FOCAL LENGTH

Focal length is the distance (in mm.), in an optical system. It is a measurement from the lens (or primary mirror) to the point where the telescope is in focus (focal point). The longer the focal length of the telescope, generally the more power it has, the larger the image and the smaller the field of view. Use the following formula to determine the focal length of a telescope: Focal length is the aperture (in mm) times the focal ratio. For example, the focal length of an 8" (203.2mm) aperture with a focal ratio of f/10 would be $203.2 \times 10 = 2032\text{mm}$.

OBJECTIVE LENS SIZE (Aperture)

Aperture size is the single most important factor in choosing a telescope. Aperture is the diameter of the lens or mirror (in mm.). Since the primary function of a telescope is to collect or “gather” incoming light, at any given magnification the larger the aperture the better the viewed image will be. It is important to remember that the larger the objective lens mirror the better, but the size of the lens or mirror diameter limits the amount of power that can be used. The higher the magnification, the less bright the image will be since more light will be distributed over a larger area.

MAGNIFICATION (Power)

Magnification is the number of times the object being viewed is enlarged. The magnification of a telescope is a function of the focal lengths of the tube and eyepieces. To calculate magnification: Divide the focal length of optical tube by the focal length of eyepiece that is being used. For example, a 700mm telescope with a 4mm eyepiece would magnify objects 175x (700 divided by 4).

ACCESSORIES

Barlow Lens

This is an auxiliary eyepiece lens that increases (multiplies) power by a given factor, which is usually 2x or 3x.

Erecting Eye Prism

This lens corrects the inverted (upside down) image when viewing land-based objects seen through a reflector type telescope.

Finderscope

This is a low-powered sighting scope mounted on the top of the telescope's optical tube and has a reticle or an illuminated red dot that allows you to quickly locate the object being viewed.

Focusing Knob

Controls the rack and pinion focusing system and enables smooth and precise movement of the eyepiece to bring objects into sharp focus.

TELESCOPE EYEPIECES

Eyepieces are interchangeable and provide a variety of magnification and field of view options. Use an eyepiece with low magnification to view the Moon, planets, star clusters, nebulae and constellations. The lower the magnification, the wider the field of view. An eyepiece with high magnification enables you to view details in the mountains, ridges and craters of the Moon.

TELESCOPE LIMITED LIFETIME WARRANTY

(Within USA and Canada only)

This warranty does not cover consumer-caused damages, abuse, normal wear-and-tear, unauthorized repairs or modifications. For further detailed information, please refer to the warranty policy enclosed with products.

The journey to stars and planets begins with BARSKA. BARSKA's Starwatcher telescopes are ideal entry-level telescopes for the aspiring amateur astronomer. The refractor and reflector telescope models are easy to set up and include everything necessary to begin the adventure for a lifetime including telescope, finderscope, eyepieces, mount and tripod.

Starwatcher Features

Solid refractor and reflector telescopes | All glass coated optics for enhanced image brightness | Interchangeable eyepieces with a 3x Barlow lens to increase viewing power | Reflector telescope with a rack and pinion focuser | Red Dot finderscope to help aim at sky targets (select models only) and include a 1-Year Limited Warranty | Engineered with smooth functioning mounts sturdy adjustable aluminum tripod with accessory tray (select models only) | Excellent for astronomy enthusiasts and professionals | Limited Lifetime Warranty



60050, 450 Power
AE10748
Mount: Pan-head



70060, 525 Power
AE10750
Mount: Altazimuth with slow motion altitude controls



80060, 600 Power
AE10752
Mount: Altazimuth with slow motion altitude controls



90060, 675 Power
AE10754
Equatorial Mount
With setting circles and dual slow motion adjustment cables

RED DOT FINDER
It superimposes a tiny red dot at infinity on the night sky, and shows you exactly where your telescope is pointed.



40070, 300 Power
AE10100
Mount: Table Top

Protective Carrying Case

70060, 231 Power
 AE11124
 Mount: Pan-Head



70076, 525 Power
 AE10756
 Mount: Altazimuth with slow motion altitude controls



900114, 675 Power
 AE10758
 Equatorial Mount
 With setting circles and dual slow motion adjustment cables



30070, 225 Power
 AE12932
 Mount: Table Top



70070, 525 Power
 AE12934
 Mount: Altazimuth



Model #	Optical System	Max Power	Focal Length	Objective Lens	Finder Scope	Draw Tube (inch)	Eyeiece #1	Eyeiece #2	Eyeiece #3	Barlow Lens	Erecting Eye	Diagonal	Moon Filter	Tripod	Weight (kg/lbs)
AE10100	Refractor	300	400mm	70mm	5x24	1.25	SR4	K20	No	3x	N/A	45°	No	Table Top	2.0/4.4
AE10748	Refractor	450	600mm	50mm	5x24	0.965	SR4	H20	No	3x	1.5x	90°	Yes	Aluminum	1.8/4.0
AE10750	Refractor	525	700mm	60mm	Red Dot	1.25	SR4	H12	H20	3x	1.5x	90°	Yes	Aluminum	3.2/7.0
AE10752	Refractor	600	800mm	60mm	Red Dot	1.25	SR4	H12	H20	3x	1.5x	90°	Yes	Aluminum	3.4/7.5
AE10754	Refractor	675	900mm	60mm	Red Dot	1.25	SR4	H12	H20	3x	1.5x	90°	Yes	Aluminum	6.8/15.0
AE10756	Reflector	525	700mm	76mm	Red Dot	1.25	SR4	H12	H20	3x	No	No	Yes	Aluminum	6.3/13.9
AE10758	Reflector	675	900mm	114mm	Red Dot	1.25	SR4	K20	No	3x	No	No	Yes	Aluminum	11.5/25.4
AE11124	Refractor	231	700mm	60mm	5x20	1.25	K9	K25	No	3x	N/A	N/A	No	Aluminum	3.62/8
AE12932	Refractor	225	300mm	70mm	N/A	N/A	H4	H20	No	3x	N/A	90°	No	Aluminum	2/4.4
AE12934	Refractor	525	700mm	70mm	5x24	1.25	K4	K9	K20	3x	N/A	90°	No	Aluminum	2.7/6

Astronomical images appearing in this catalog are courtesy of NASA. These images are intended for graphic illustration purposes only and do not represent the appearance of celestial objects as seen through BARSKA telescope and binocular products.

Anchormaster Telescopes

What better way to gaze at the stars or your favorite scenic view than through a gorgeous Anchormaster telescope. Anchormasters feature quality construction, high quality optics and are elaborately detailed in polished brass with mahogany finish tripod. Anchormaster is a grand addition to any décor.

Anchormaster Telescope Features

Elaborately detailed and polished brass telescopes | Fully coated achromatic lenses for brilliant images | Structured in a refractor design | High quality Plössl interchangeable eyepieces with a rack and pinion focuser (Only one eyepiece included) | Equipped with 45° erecting diagonal for correct image of land viewing | Brass cradle mounts allows the scope to move smoothly in all directions | Handcrafted Mahogany tripods with extendable legs and polished brass stabilizing chain | Ideal for celestial viewing of planets or terrestrial viewing of the beautiful cityscape



36 Power, 90080 AE10824

Maximum Power: 36x
Focal Length: 900mm
Objective Lens: 80mm
Eyepiece: 25mm Plössl
Eyepiece Size: 1.25mm



28 Power, 70060 AE10822

Maximum Power: 28x
Focal Length: 700mm
Objective Lens: 60mm
Eyepiece: 25mm Plössl
Eyepiece Size: 1.25mm



Anchormaster Telescopes

Anchormaster is a classic and elegant series with precision brass scopes that sweeps you back to the days of tall ships and pirates. Handcrafted from solid brass and mahogany wood, these majestic masterpieces are pure sophistication. The scope itself is a spectacular sight and accents your home with a view. They are excellent at transforming distance images into a spectacular visual experience. At an amazing value, Anchormaster will take your breath away!



20-60x60 Scope
AA11128
 · 20-60x Zoom Power
 · 60mm Objective Lens
 · Mounted on a standing mahogany floor tripod



32x80 Scope
AA10620
 · 32x Fixed Power
 · 80mm Objective Lens
 · Length: 40"
 · Mounted on a standing mahogany floor tripod



18x50 Scope
AA10618
 · 18x Fixed Power
 · 50mm Objective Lens
 · Length: 20"
 · Mounted on a standing mahogany floor tripod

15-45x50 Scope
AA10616
 · 15-45x Zoom Power
 · 50mm Objective Lens
 · Mounted on a standing mahogany floor tripod



Anchormaster Scope Features

Fully coated achromatic lenses for brilliant images | Structured in a refractor design with helical focusing rings | Internal image-correcting lens provides right-side-up images for the naked eye | Brass mounts allows the scope to move smoothly in all directions | Mahogany tripods with extendable legs and polished brass joints | Ideal for celestial viewing of planets or terrestrial viewing of the beautiful cityscape



BlueLine Connoisseur

Get three times closer to the stage with BARSKA's line of Opera Glasses. Crafted from highly polished brass, with color accents that serves to enhance their elegance, quality coated optics for crisp clear images. After the show comes to an end, simply place your opera glasses in the included elegant leatherette pouch as you make your way to the rest of your evening. Whether you choose any of these products for yourself or as a gift, you will be making an investment in an elegant product that will provide years of enjoyment. Backed by BARSKA'S Limited Lifetime Warranty.



**3x25
Opera Glasses w/Light**
AB11280

- Pearl white accent
- Styled with gold-trim necklace
- Crafted with red reading light
- Includes leatherette pouch



**3x25
Opera Glasses**
AB10190

- Styled with gold-trim necklace
- Center focus wheel
- Includes leatherette pouch



**3x25
Opera Glasses w/Handle**
AB11282

- Silver brushed metal accent
- Handle doubles in length for custom viewing
- Center focus wheel
- Includes leatherette pouch

Classic Connoisseur Collection

There is nothing that expresses classic elegance and traditional sophistication more than brass. BARSKA's Classic Connoisseur Collection is in a class by itself. These precision-made, high quality optics products make a stunning addition to any décor and are as functional to use as they are beautiful to look at.

5 Bright White LED Lights
and 1 UV Light



**4x, 64mm Magnifier
w/5 LED Lights, 1 UV Light**

BB11917

- Provides a bright and clear view even in the dark
- UV light to reveal markings on some currency such as: watermarks, security threads and or holograms
- Designed for a comfortable hold
- Runs on two AAA batteries (not included)



3x, 90mm Magnifier Set

AR10858

- A polished brass set of a 3x, 90mm handheld magnifier
- 40mm table magnifier
- Elegant and unique
- Made of high quality glass lens and ideal for any magnifying purposes
- Perfect as gifts or as a desktop accessory

6x30 Spyscope

AA11126

- 6x magnification
- 30mm objective lens
- Mounted on a desktop mahogany pedestal



15-45x50 Spyscope

AA10614

- 15-45x zoom
- 50mm objective lens
- Mounted on a desktop mahogany pedestal



25x30 Spyscope

AA10200

- Precision crafted brass spyscope with high power collapsible focusing eyepiece
- Includes leatherette case



**18x50
Collapsible Spyscope**

AA10612

- 18x fixed power
- 50mm objective lens
- Extends to 28" for viewing and collapses for storage
- Includes elegant mahogany storage chest



Pro Metal Detector Field Kit
BE12746

Includes headphones, pick shovel and soft carrying case.



Metal Detector

Waterproof search coil | Detection results are displayed on the view meter | Visual blue LED indicators | Audio tone indicator | Rubberized handgrip

Headphones

Adjustable padded headband | Padded ear cushions | Single sided long cord with volume control | Delivers crisp audio | No batteries needed

Multi Use Pick Shovel with Compass

Folding pick | Folding shovel | Bottle opener | Compass built into the handle | Serrated edge | Rubberized grip | Folds down to 11" for storage | Locking screw for safety

Soft Carrying Bag

One main compartment | Two exterior pockets | Two carrying handles | 45" Inches in length | Includes carrying strap

Pursuit Metal Detector Field Kit
BE12748

Includes hand held metal detector, headphones, pick shovel and soft carrying case.



Metal Detector

Waterproof search coil | Easy to read LCD display that gives a visual indication of what has been found and probably depth of target Distinctive tones for different types of metals | Rubberized handgrip

Handheld Metal Detector

Vibrating pulse indicator | Visual light indicator | 360 degree scan coverage | Ergonomic design | Durable construction | Built-in LED flashlight | Convenient carry holster | Easy to use | Water resistant | Length: 11 in.

Headphones

Adjustable padded headband | Padded ear cushions | Single sided long cord with volume control | Delivers crisp audio | No batteries needed

Multi Use Pick Shovel with Compass

Folding pick | Folding shovel | Bottle opener | Compass built into the handle | Serrated edge | Rubberized grip | Folds down to 11" for storage | Locking screw for safety

Soft Carrying Bag

One main compartment | Two exterior pockets | Two carrying handles | 45" Inches in length | Includes carrying strap

Model #	Description	Search Modes	Audio Tone ID Levels	Search Coil Inch	Total Length Min-Max Inch	Weight lbs	Batteries	Includes
BE12746	Pro Metal Detector Field Kit	2	1	7.5	37.4 - 43.3	1.95	1 x 9V	Headphones, Multi Use Pick Shovel and Carrying Case
BE12748	Pursuit Metal Detector Field Kit	3	3	10	41.73 - 48.42	3.5	2 x 9V	Headphones, Multi Use Pick Shovel and Carrying Case



Premiere Edition Metal Detector
BE11924

100% submersible metal detector, works in fresh and salt water up to 32.8 feet/10 meters | Distinctive patterned tones for different types of metals | Padded armrest and arm rest strap | Rubberized handgrip



Master-200 Metal Detector
BE12596

Waterproof search coil | Easy to read LCD display that gives a visual indication of what has been found and probably depth of target | Distinctive patterned tones for different types of metals | Rubberized handgrip



Sharp Edition Metal Detector
BE11922

Waterproof search coil | Easy to read LCD display that gives a visual indication of what has been found and probably depth of target | Distinctive patterned tones for different types of metals | Padded armrest | Rubberized handgrip



Pursuit-300 Metal Detector
BE12972

Waterproof search coil | Easy to read LCD display that gives a visual indication of what has been found and probably depth of target | Distinctive tones for different types of metals | Rubberized handgrip | LED backlight helps users to use the detector at night | Pinpointing function lets users locate the target more precisely

Model #	Description	Search Modes	Audio Tone ID Levels	Search Coil Inch	Total Length Min-Max Inch	Weight lbs	Batteries	Includes
BE11924	Premiere Edition Metal Detector	2	1	10"	37.4 - 47.25	5.5	8 x AA	Carrying Case, Headphones and Arm Rest Strap
BE12596	Master-200 Metal Detector	4	3	10"	41.73 - 47.63	2.4	2 x 9V	N/A
BE11922	Sharp Edition Metal Detector	3	3	8.5"	47.24 - 55.90	2.65	8 x AA	Carrying Case
BE12972	Pursuit-300 Metal Detector	4	3	10"	41.73-48.42	2.5	2 x 9V	N/A



Pro-400 Metal Detector w/ 4-Color LED Indicator
BE13230

Waterproof search coil | Visual 4-Color LED indicator | Distinctive tones for different types of metals | Selectable Eliminator knob can let users ignore undesired targets | Rubberized handgrip



Pursuit-200 Metal Detector
BE12594

Waterproof search coil | Easy to read LCD display that gives a visual indication of what has been found and probably depth of target | Distinctive tones for different types of metals | Rubberized handgrip



Pro-300 Metal Detector
BE12970

Waterproof search coil | Easy to read LCD display that gives a visual indication of what has been found and probably depth of target | Distinctive tones for different types of metals | Ergonomic handgrip



Pursuit Edition Metal Detector
BE11642

Waterproof search coil | Easy to read LCD display that gives a visual indication of what has been found and probably depth of target | Distinctive patterned tones for different types of metals | Padded armrest | Rubberized handgrip

Model #	Description	Search Modes	Audio Tone ID Levels	Search Coil Inch	Total Length Min-Max Inch	Weight lbs	Batteries	Includes
BE12594	Pursuit-200 Metal Detector	3	3	10"	41.73 - 48.42	2.3	2 x 9V	N/A
BE11642	Pursuit Edition Metal Detector	3	3	10"	40.15 - 48.80	2.35	2 x 9V	N/A
BE12970	Pro-300 Metal Detector	2	3	7.5"	29.92 - 42.13	1.65	1 x 9V	N/A
BE13230	Pro-400 Metal Detector	2	4	7.5"	35 - 45	1.85	2 x 9V	N/A



Pro-200 Metal Detector
BE12592

Waterproof search coil | Detection results are displayed on the view meter | Visual blue LED indicators | Audio tone indicator Rubberized handgrip



Pro Edition Metal Detector
BE11638

Waterproof search coil | Detection results are displayed on the view meter | Adjustable arm rest | Audio tone indicator | Adjustable sensitivity



D-80 Metal Detector
BE13248

Waterproof search coil | Detection results are displayed on the view meter | Audio tone indicator | Adjustable Sensitivity | Ergonomic handgrip



Sharp Junior Edition Metal Detector
BE13228

Waterproof search coil | Easy to read LCD display that give a visual indication of what has been found and probably depth of target | Distinctive tones for different types of metals | Selectable "DISC" button can let users ignore undesired targets

Model #	Description	Search Modes	Audio Tone ID Levels	Search Coil Inch	Total Length Min-Max Inch	Weight lbs	Batteries	Includes
BE12592	Pro-200 Metal Detector	2	1	7.5"	37.4 - 43.3	2.1	1 x 9V	N/A
BE11638	Pro Edition Metal Detector	2	1	6.5"	34.6 - 42.9	2.5	2 x 9V	N/A
BE13248	D-80 Metal Detector	2	1	7.5"	30 - 43	2.5	1 x 9V	N/A
BE13228	Sharp Junior Edition Metal Detector	2	3	7.5"	26-36	1.4	1 x 9V	N/A



Surveyor-100 Hand Held Metal Detector
BE12744

Capable of detecting in any position and at any angle | Vibrating pulse indicator | Visual light indicator | 360 degree scan coverage | Ergonomic design | Durable construction | Built-in LED flashlight | Compact and lightweight | Easy to use | Water resistant | Includes carry holster



Handheld Metal Detector
BE12232

Detection results are audio and visual | Adjustable sensitivity | Can be used in tight spaces where metal objects may exist | Lightweight and compact | Includes wrist strap

Model #	Description	Search Modes	Audio Tone ID Levels	Search Coil Inch	Length	Weight lbs	Batteries	Includes
BE12744	Surveyor-100 Hand Held Metal Detector	1	1	na	11"	0.3	9V	Holster
BE12232	Handheld Metal Detector	1	1	6	14"	.45	9V	Wrist Strap



Foldable Metal Shovel w/Bag
AF13292

Durable steel construction | Compact folding design | Converts to a pick for added utility | Serrated edge | Built-in compass | Bottle opener | Includes soft carrying case



Shifter, Shovel and Rake
AF12270

Consists of the most important hand tools that are needed to get started in recovering valuable objects when searching in sand or soft Earth | Non-metallic | Sifter separates findings from the silt | Hand rake helps to loosen soil | Hand shovel features inches and centimeter markings on the blade



Headphones
AF12274

Padded ear cushions | Adjustable padded headband | Single sided long cord with volume control | No batteries needed | Cable length 6.56ft / 2m.



Carrying Bag
AF11658

Will fit most Barska metal detector | Made from soft but strong material | 2 outside zippered pockets | Long zippered main compartment with a large interior space | 2 carrying handles | 45" inches in length | 11" inches wide | Includes adjustable carrying strap



MICROSCOPES

COMPOUND • STEREO • DIGITAL

BARSKA Microscopes

The avid nature enthusiast knows that enjoying the great outdoors doesn't always mean appreciating nature's largest and rarest of animals. Sometimes, a fond appreciation of nature means looking into the cells, bacteria, and tissue, which make life itself one of the great wonders of the world. That's where Barska microscopes come in, and a company as committed to optics as Barska would be remiss if it didn't offer industry-leading microscope products

Barska understands that consumers have a wide range of needs when it comes to using microscopes to their fullest potential, and that's why it has crafted a long line of microscopes that are quite varied in style. Indeed, the company pairs traditional, laboratory-style products with handheld monocular microscopes that can be used right out among nature rather than forcing the enthusiast indoors to look at their findings.

MICROSCOPE TERMINOLOGY

A microscope is an instrument for viewing objects that are too small to be seen by the naked or unaided eye. The science of investigating small objects using such an instrument is called microscopy. The term microscopic means minute or very small.

TYPES OF MICROSCOPES

Compound

Constructed with two optical paths at the same angle. The compound microscope has two systems of lenses for greater magnification. The objective lens provides the primary magnification which is compounded (multiplied) by the ocular lens (eyepiece). Images produced by compound microscopes are two dimensional. This type of microscope is used to study very small specimens on a slide.

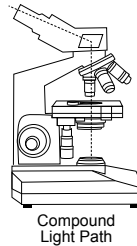

Stereo

Designed with two separate optical paths with two objectives and two eyepieces to provide slightly different viewing angles to the left and right eyes. In this way it produces a 3-D visualization of the sample being examined. The zoom provides different magnification and features an inversion system which allows the image to be viewed normally and right side up. This type features a large stage for closer viewing of the non-microscopic world like rocks, insects, flowers, and dissection specimens and does not need to be mounted on a slide.

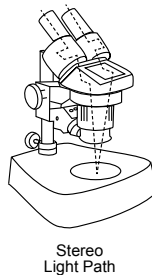

Digital Microscopes

BARSKA's digital microscopes are state-of-the-art integration of high quality microscope and a digital camera. Simply connect the microscope to the computer with the USB cord to magnify the object and view them on your PC screen and with option to save. Digital microscopes are great for educational purposes because several people can view the specimen at once, unlike a traditional microscope where one person can view at time.

POWER

Total Magnification

Total magnification is calculated by multiplying the magnification of the eyepiece by the magnification of the objective. $10x(\text{eyepiece}) \times 4x(\text{objective}) = 40x$ Total Magnification



Zoom Magnification

Zoom models allow the user to zoom or change magnification continuously throughout the magnification range providing a low to high power range. For example, a 7x-45x microscope has the ability to magnify the object 7 to 45 times higher than an unaided eye.



WIDEFIELD EYEPIECE (WF)

An eyepiece with an achromatic doublet lens designed in such a way that it does not have to be limited to viewing only in its center, and the portion of the lens that allows non-distorted viewing is larger than a normal lens. This appears to the user as a bigger aperture or "hole" to look through. It therefore has the advantage of being easier to use and more forgiving of a user's head movements. An eyepiece listed as WF10X/18mm would indicate it has a widefield achromatic doublet lens, 10x magnification and is 18mm in diameter

INTERPUPILIARY DISTANCE ADJUSTMENT

When using a binocular microscope with interpupiliary adjustment, there is an adjustment for the distance between the viewers' eyes.

A young child will have a small interpupiliary distance (IPD) while an adult will have a larger one. The eyepiece lenses will spread apart or get closer together to fit each individual.

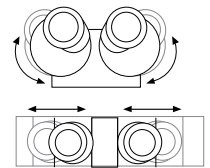

MICROSCOPE HEAD

The head refers to the upper part of the microscope that contains the eyepiece tube and prisms.

Monocular

Contains one eyepiece



Binocular

Binocular has two eyepieces, one for each eye



Trinocular

The third vertical viewing port can be used with an eyepiece for a second person, such as an instructor, or can be used with an adapter for video or still camera.



ILLUMINATION

Transmitted and Oblique Illumination

Oblique lighting or top lighting shines down and reflects off opaque or solid specimens. Transmitted lighting or bottom lighting shines up through transparent objects. Not all microscopes will have these types of illumination.

Mirror

Mirrored illumination is a simple and inexpensive lighting system that uses light from an external source (in direct sunlight, lamp etc) and reflects it upward to the condenser/specimen from a mirror located below the stage.

Fluorescent

Fluorescent illumination provides a cool bright light. Ideal when viewing slides for long periods or studying live cellular specimens.

Halogen

Halogen illumination provides the very brightest illumination, but tends to give off heat.

DIAPHRAGM

Generally a five-hole disc placed under the stage on a high power microscope. Each hole is a different diameter. By rotating it, you can vary the amount of light passing through the stage opening. This will help to properly illuminate the specimen and increase contrast and resolution. The diaphragm is most useful at the higher powers.

WORKING DISTANCE

This is the distance between the specimen or cover slip and the objective lens. On compound microscopes that use slides, the stage is adjustable allowing the user to zoom in or out of an image. On stereo microscope the stage is fixed.

ADJUSTMENTS

Coarse Focus

This is the rough focus knob on the microscope. You use it to move the objective lenses toward or away from the specimen. Generally use the coarse focus first to get close then adjust the fine focus knob for fine tuning.

Fine Focus

This is the knob used to fine tune the focus on the specimen. It is also used to focus on various parts of the specimen.

WARRANTY

Microscope 1-Year Limited Warranty USA and Canada Only, This warranty does not cover consumer caused damages, abuse, normal wear-and-tear, unauthorized repairs or modifications. For more information, refer to enclosed warranty with products.

DIGITAL MICROSCOPE

40x, 100x, 400x, 4MP Digital Microscope with Screen and Eyepiece
AY12226



Microscope with Digital Camera

Barska's Digital Microscope with 3.5" LCD color screen and 10x eyepiece gives you the option of viewing the specimen through the screen or through a traditional 10x eyepiece. It's like having two microscopes in one. Screen module is packed with features that manipulate images and videos. Images and videos can be saved on the internal 128MB memory, expand the memory up to 8G with the external memory SD/MMC slot or transferred to a computer through the USB cable. Features a specimen holder with mechanical stage. The specimen holder keeps the specimen slide in place and can smoothly move the slide back and forth as well as from side to side. Includes 4 specimen samples, 5 prepared slides, 5 blank slides, hatchery, tweezers, USB cable, AC adapter, plastic dust cover and hard carrying case

Features

16x, 40x, 160x Magnification with LCD screen | 40x, 100x, 400x Magnification with eye piece | 4MP Digital camera with 8x digital zoom | 3.5" color screen with display menu | Rotating 4x, 10x, 40x objective turret | Screen module takes images and video | 5 position colored wheel filter | LED transmitted and oblique lighting | Stage dimension of 90mm x 90mm | Compatible with Window XP and Windows Vista



Model	Description	Magnification	Lens	Working Distance	Image Sensor	Picture Size Video/fps	Adjustment Knob Type	Illumination	Weight (kg)
AY12226	4MP Digital Microscope with 3.5" Screen and Eyepiece	16x, 40x, 160x with screen 40x, 100x, 400x, with eye piece	4x, 10x, 40x	Adjustable	4 MP	4023x3024~ 640x480 24/fps	Coarse and Fine	LED	1.58 with screen 1.47 with eyepiece



300x, 600x, 1200x Monocular Compound Microscope Explorer Kit
AY12938

With the 20x eyepiece and 3 objective lenses 15x, 30x and 60x, you can achieve magnifications ranging from 300x, 600x to 1200x. The electric LED lighting that provides bright, natural illumination while staying cool to the touch. The illuminator operates on two AA batteries (not included). Built-in coarse and fine focus adjustments allow users to locate the target accurately and provide sharper image detail. The stage has stage clips that secure the slide or specimen in place during viewing. Grow your own brine shrimp and watch them grow with the included eggs and hatchery. The colored wheel filters enhances details of a specimen. Includes almost everything you need to start exploring the microscopic world today.

- Includes**
- 7 - Slide Covers
 - 7 - Blank Slide Labels
 - 7 - Blank Slides
 - 5 - Prepared Slides
 - 2 - Collecting Vials
 - 1 - Eosin
 - 1 - Brine Shrimp Eggs
 - 1 - Shrimp Hatchery
 - 1 - Micro Slicer
 - 1 - Needle
 - 1 - Graduated Cylinder
 - 1 - Sea Salt
 - 1 - Petri Dish
 - 1 - Replacement Light Bulb
 - 1 - Tweezers
 - 1 - Gum Media
 - 1 - Scalpel
 - 1 - Stirring Rod
 - 1 - Carrying Case

40x-640x Student Monocular Compound Microscope
AY13286

An excellent device for educational applications and comes with everything educators and students need to start exploring the world of microscopes. The user-friendly features of this Compound Microscope give young scientists a hands-on learning experience while high quality optics deliver impressive detail. A rotating nose piece allows the user to switch between the 4x, 10x, and 40x objective lenses. Includes both prepared and blank slides, allowing students and enthusiasts the opportunity to readily view prepared specimens, or create their own samples.

- | | |
|---|---|
| <p>Features</p> <ul style="list-style-type: none"> - 40x to 640x Magnification - 360° Rotating Head / 45° Viewing - 4x, 10x, 40x Objectives - WF10x and 16x Eyepieces - Coarse Focusing Knob - LED Illumination - Transmitted and Oblique - Working Interpupillary Distance: 70mm | <p>Includes</p> <ul style="list-style-type: none"> 7 - Blank Slides and Labels 5 - Prepared Slides 1 - Forcep |
|---|---|



50 Blank Slides with Wooden Case
AF11636

50 Prepared Slides with Wooden Case
AF11942

100 Prepared Slides with Wooden Case
AF11944

Model #	Type	Magnification	Objective	Eye Piece	Working Distance	Adjustment Knob Type	Illumination	Body Material	Weight (kg)
AY12938	Compound	300x, 600x, 1200x	15x, 30x, 60x	20x	Adjustable	Coarse and Fine	LED and Mirror	Metal	1.31
AY13286	Compound	40x, 64x, 100x, 160x, 400x, 640x	4x, 10x, 40x	10x, 16x	Adjustable	Coarse	LED	Metal	0.68

Stereo Zoom Power Microscopes

Zoom models allow the user to zoom or change magnification continuously throughout its magnification range providing a low to high power range. For example the 7x-45x microscope has the ability to magnify the object 7 to 45 times higher than an unaided eye.

7x-45x Trinocular Stereo Zoom Microscope
AY13178

Features

- 7x-45x Zoom magnification
- 10x Wide Field Eyepiece
- Head Rotates 360°
- Transmitted and Oblique Illumination
- Coarse Adjustments
- Interpupillary Distance Between 55mm-75mm
- Out-Of-The-Box Set-Up
- Easy to Use

Includes

- Spare Bulb
- Fuse
- Power Cord
- Specimen Plate

Ideal For

- General Medical Applications
- Industrial Use
- Hobbyists/Collectors
- Educational Fields



Stereo Microscopes

Constructed with two separate light paths which results in a true stereo, or three dimensional (3-D) image of the specimen at it's lowest power. Within the objective lens of this microscope you will find two lenses (one for each path of light) side-by-side. This microscope features a large

stage for closer viewing of the non-microscope world. Items such as insect, plant and flower parts, stamps, coins, PC boards, etc.

20x, 50x Student Binocular Stereo Microscope
AY13116

Features

- 20x, 50x Magnification
- WF10x, 25x Eyepieces
- Oblique Illumination
- Coarse Adjustments
- Interpupillary Distance Between 55mm-75mm

Includes

- 7 Blank Slides, Labels and Cover Slips
- 5 Prepared Slides
- 1 Forcep
- 1 Granite Fragment

Ideal For

- General Medical Applications
- Industrial Use
- Hobbyists/Collectors
- Educational Fields



20x, 40x Binocular Stereo Microscope
AY13180

Features

- 20x, 40x Magnification
- 10x Wide Field Eyepiece
- Head Rotates 360°
- Transmitted and Oblique Illumination
- Coarse Adjustments
- Interpupillary Distance Between 55mm-75mm

Includes

- Spare Bulb
- Fuse
- Power Cord
- Specimen Plate
- Plastic Dust Cover

Ideal For

- General Medical Applications
- Industrial Use
- Hobbyists/Collectors
- Educational Fields



Model #	Type	Magnification	Objective	Eye Piece	Working Distance	Adjustment Knob Type	Illumination	Body Material	Weight (kg)
AY13178	Stereo	7x-45x	0.7x-4.5x	WF10x, 20mm	100mm	Coarse	12V 15W Halogen	Aluminum Alloy & Copper	4.18
AY13116	Stereo	20x, 50x	2x, 4x, 10x	WF10x, 25x	70mm	Coarse	LED	Plastic	0.9
AY13180	Stereo	20x, 40x	2x, 4x	WF10x, 20mm	60mm	Coarse	12V 10W Halogen	Aluminum Alloy & Copper	2.20

 **BARSKA**[®]
SINCE 1994
VALUE. QUALITY. NEW TECHNOLOGY.



BARSKA[®]
855 Towne Center Drive Pomona, CA 91767, U.S.A
Tel: 888.666.6769 Fax: 909.445.8169
www.barska.com



©2022 BARSKA[®]

Product design and specifications are subject to change without notice

Printed in the USA